



---

Touch-Roll Type

VND Thickness Measurement Converter

(1 mm, 2 mm Range)

Instruction Manual

---

- Carefully read and understand this manual before using the product.
- After reading this manual, store it in a safe location so that it can be referenced readily as required.

---

Thank you for purchasing this Touch-Roll Type VND Thickness Measurement Converter.

This instruction manual describes the how to use the Touch-Roll Type VND Thickness Measurement Converter (hereinafter referred to as "this product" or "the product") and the precautions for using it.

■ Important information ■

- ▶ Carefully read and understand this manual before using this product. Store this manual in a safe location so that it can be referenced readily as required.
- ▶ If you have any questions regarding this manual or this product, contact your dealer.
- ▶ When using this product, it is necessary to be knowledgeable about not only the contents of this manual, but also regarding the instrumentation and equipment connected to this product. For safety, it is necessary to have standard knowledge regarding safety in addition to the contents described in this manual.
- ▶ When combining this product with other instrumentation or equipment and then selling or transferring ownership as an assembly, always make sure to attach this manual as well and provide it to the end user.
- ▶ When disposing of this product, make sure to follow all local laws and regulations.
- ▶ This manual contains some explanations for parts of other separately sold equipment, in order to explain their attachment to this product.
- ▶ The illustrations of parts that are sold separately in this manual may differ from their actual appearance.
- ▶ Any company names and product names listed in this manual are the trademarks or registered trademarks of their respective companies.
- ▶ SHINKAWA Sensor Technology, Inc. owns the copyright to this manual. Unauthorized publication of this content, and any and all copying/duplication of the content are prohibited.

■ Exclusion from liability ■

- ▶ SHINKAWA Sensor Technology, Inc. shall not be liable for any damages or injuries arising from not following the instructions indicated in this manual, or from carelessness or neglect while handling this product or during its installation.
- ▶ Compensation shall not be made for any damage, injury, or loss that occurs as a direct or indirect result of the incorrect use, improper use, modification, or disassembly of this product.
- ▶ SHINKAWA Sensor Technology, Inc. will not take any responsibility for any items not listed in this document and in the warranty, including the guarantee of product merchantability, guarantee for specific objectives or specifications, or for violation of patents, whether they are expressed or implied.
- ▶ The warranty for this product is at the end of this manual. If a breakdown occurs in this product, repairs will be performed according to this warranty.
- ▶ SHINKAWA Sensor Technology, Inc. will not take any responsibility for any and all results from using parts other than those recommended by our company.

■ Confirmation of this product and package items ■

SHINKAWA Sensor Technology, Inc. performs strict quality control and quality inspections to provide reliable products. When this product first arrives, please check that it is the correct ordered product, that there was no damage to it during its transportation, and that all accessories (ordered items) are provided in the package.

If there is damage to this product or missing accessories (ordered items), contact your dealer immediately.

Index

	Page
Important information .....	1
Exclusion from liability .....	2
Confirmation of this product and package items .....	2
 Chapter 1 For Safe Use of the Product .....	 5
1.1 Warning symbols .....	5
1.2 Precautions for handling .....	5
1.3 Installation and wiring methods in accordance to EMC directives .....	7
 Chapter 2 Introduction .....	 8
2.1 Product features .....	8
2.2 Measurement principles .....	8
2.3 Measuring thickness in combination with the touch-roll attachment .....	9
2.4 Specifications .....	10
2.4.1 1 mm range product specification .....	10
2.4.2 2 mm range product specification .....	12
2.5 Dimensions and part names .....	14
2.5.1 Sensor .....	14
2.5.2 Extension cable .....	15
2.5.3 Converter .....	16
2.5.4 Touch-roll attachment .....	17
2.6 System configuration .....	18
2.6.1 Shape and material of the target .....	19
2.6.2 Combination .....	19
 Chapter 3 Installation .....	 20
3.1 Installation environment .....	21
3.1.1 Installation environment for the converter .....	21
3.1.2 Installation environment for the sensor .....	22
3.1.3 Installation environment for the extension cable .....	23
3.2 Installing the converter .....	23
3.3 Installing the sensor .....	24
3.3.1 When installing the touch-roll attachment .....	24
3.3.2 When installing a bracket .....	26
3.4 Connections .....	28
3.4.1 Sensor connection to the converter .....	28
3.4.2 Power supply and analog output connections .....	28

---



3.5 Adjusting the weight position of the touch-roll attachment.....	29
3.5.1 Adjusting the weight position .....	29
3.5.2 Part names .....	29
3.5.3 Coarse adjustment of the weight position .....	30
3.5.4 Fine adjustment of the weight position.....	31
3.5.5 Confirming the operation.....	31
Chapter 4 Pre-operation Procedures .....	32
4.1 Basic use.....	32
Chapter 5 Warm-up Operation .....	33
Chapter 6 Functions .....	34
6.1 LED display panel and button panel descriptions.....	34
6.2 Teaching function.....	35
6.3 Using the teaching function .....	35
6.3.1 Using the 6-point adjustment function.....	37
6.3.2 Using the 11-point adjustment function.....	44
6.4 Zero shift function.....	56
6.5 Using the zero shift function .....	56
6.6 Correction function .....	59
6.6.1 Using the 2-point correction function (zero point, span point) .....	60
6.6.2 Using the 3-point correction function (zero point, midpoint, span point) .....	63
6.7 Button lock function .....	67
6.8 Reset function .....	68
Chapter 7 State Transition Diagrams through Button Operation .....	69
Chapter 8 Troubleshooting.....	70
Chapter 9 Maintenance/Inspection.....	71
9.1 Periodic inspection .....	71
9.2 Cleaning .....	71
9.3 Recommended replacement cycle .....	71
Chapter 10 Individual Characteristics Data (Examples) .....	72
10.1 Standard static characteristics .....	72
10.2 Temperature characteristics of the sensor .....	73
10.3 Temperature characteristics of the extension cable .....	74
10.4 Temperature characteristics of the converter .....	75

## Chapter 1 For Safe Use of the Product

For the safe use of the product, make sure to read the instructions below.

### 1.1 Warning symbols

This manual uses the following symbols to increase awareness of possible dangers or harmful situations to the user, and to guide in the safe operation of the product. Be sure that you fully understand the contents of this manual and follow the instructions herein.

Warning symbols	Description
 <b>WARNING</b>	This symbol is used to warn against the possibility of serious or fatal injury. Always follow the instructions to ensure safety.
 <b>CAUTION</b>	This symbol is used to caution against the possibility of injury. Always follow the instructions to ensure safety.
<b>CAUTION</b>	This symbol is used to draw attention to the possibility of property damage. Always follow the instructions to prevent damage to equipment.

#### Point

Point is used to highlight some important point as well as to provide useful information.

### 1.2 Precautions for handling

For the safe use of the product, make sure to follow the precautions below.

#### ■ Prohibitions ■



Never disassemble or modify the product. Do not use the product under conditions that do not match its specifications to prevent product malfunction, fire, or injury.

---



---

**CAUTION**

Do not use radio equipment such as transceivers, or mobile phones around the product.

If the product or signal cables are subjected to electromagnetic waves, the product may not provide satisfactory precision described in the specifications.

---

■ Compliance ■



Make sure to follow the procedures described in "Chapter 3: Installation" when installing the product to prevent product malfunction, fire, or injury.

---

**CAUTION**

- Before handling the product, make sure to read the manuals for this product as well as other instruments that are to be connected.
  - Before making any contact with the product, make sure to touch metallic objects, etc. to discharge any static electricity.  
Static electricity from the human body may damage the product.
  - Do not perform insulation resistance measurements or withstand voltage tests in any places other than specified. Doing so may cause variations in measurement values.
  - When performing a megger test (insulation test) on the signal transmission cable, make sure that all the cables are disconnected from the product and other instrumentation.  
After carrying out a megger test, ensure that any accumulated charge is discharged by short-circuiting prior to reconnection.  
Connecting the cables to the product or instrumentation while they still carry a charge may damage the product.
  - Contact the sales office you purchased the product from if any of the following occurs.  
Continued use of the product under any of the conditions below may result in fire or malfunction.
    - A strange smell is coming from the product
    - The product is overheated
    - The product is dropped
    - The product packaging is damaged
  - Do not store the product under direct sunlight and make sure the conditions below are satisfied. Do not store it in a hot and humid location or any location where corrosive gases are present.
    - Ambient temperature: -10°C to 60°C
    - Ambient humidity: 20% RH to 95% RH (no condensation)
-



### 1.3 Installation and wiring methods in accordance to EMC directives

This product can be compliant to IEC 61326-1 Class A by implementing the following installation and wiring methods.

#### Installation

- Install the converter inside a control panel which implements EMC measures.

#### Wiring

- For the converter's +24 VDC power supply, use a surge protector to supply power as described below.

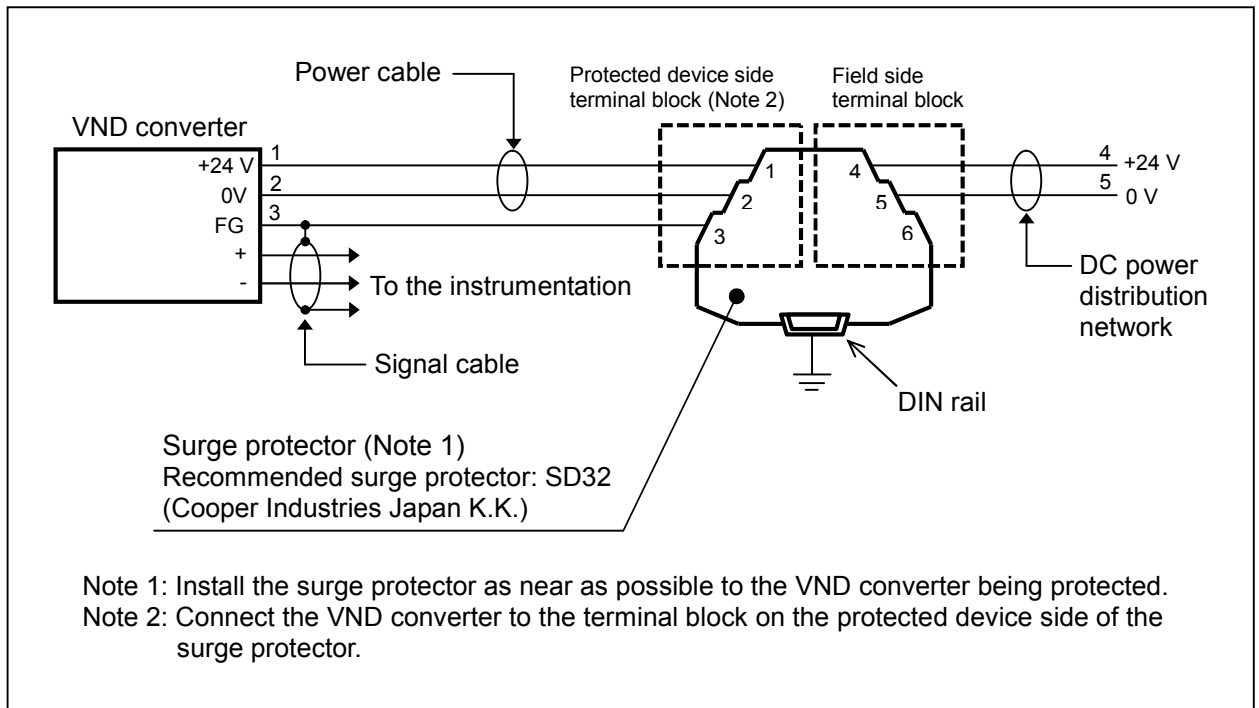

- Use a twisted pair shielded cable for the signal cable which connects the converter and instrumentation. Make the length of the unshielded part as short as possible.
- Route the extension cable, signal cable, and power cable which connects to the converter, through the ferrite core near the converter. Recommended ferrite core: RFC-20 (Kitagawa Industries Co., Ltd.)
- Perform an external shielding process (run cables through a conduit pipe grounded at both ends) on the sensor cable and extension cable.

#### CAUTION

Measures for standards compliance may vary depending on the device connected to the product, the wiring to the product, or the configuration of the control panel. Therefore, you will need to verify compliance of the combined system equipment as a whole with the CE marking.

## Chapter 2 Introduction

### 2.1 Product features

This product, in combination with an eddy current type non-contact displacement sensor and the touch-roll attachment, is a system that measures the thickness of the non-conducting sheets with high accuracy. It works as an applied product which takes advantage of SHINKAWA's eddy current type non-contact displacement sensor technology.

This product has the following main features:

- With simple button operations, converter adjustments can be performed in a short period of time.
- It is equipped with a digital display which provides assistance in making converter adjustments.
- It achieves high linearity through a high precision linearizer.
- High precision measurements can be achieved due to the excellent temperature characteristics of the sensor, extension cable, and converter.

### 2.2 Measurement principles

When a high-frequency current is supplied to the sensor, a high-frequency magnetic field is generated from the sensor.

When the sensor is placed near a metallic target sensor in this state, a high frequency magnetic flux interlinks within the target and an eddy current flows to the target's surface.

The magnitude of the eddy current will vary depending on the distance between the target and the sensor. The gap between the sensor and the target is measured by detecting the changes in sensor impedance due to the variation.

### 2.3 Measuring thickness in combination with the touch-roll attachment

As shown in the diagram, the sensor is fixed to the touch-roll attachment with an offset of  $L_2 = 0.8$  mm.

Since this sensor can always measure the distance  $L_1$  to the metal roll without detecting the non-conducting sheet, the thickness  $T$  of the non-conducting sheet is obtained as  $T = L_1 - L_2$ .

And since the converter output is adjusted to generate 0 V when the distance between the sensor and metal roll is  $L_2 = 0.8$  mm, you can obtain a converter output that is proportional to the thickness  $T$  of the non-conducting sheet.

Moreover, since sensitivity is adjusted to 1 V/mm (standard) for the voltage output, it is possible to directly read the thickness without having to perform scaling using a voltmeter or recorder.

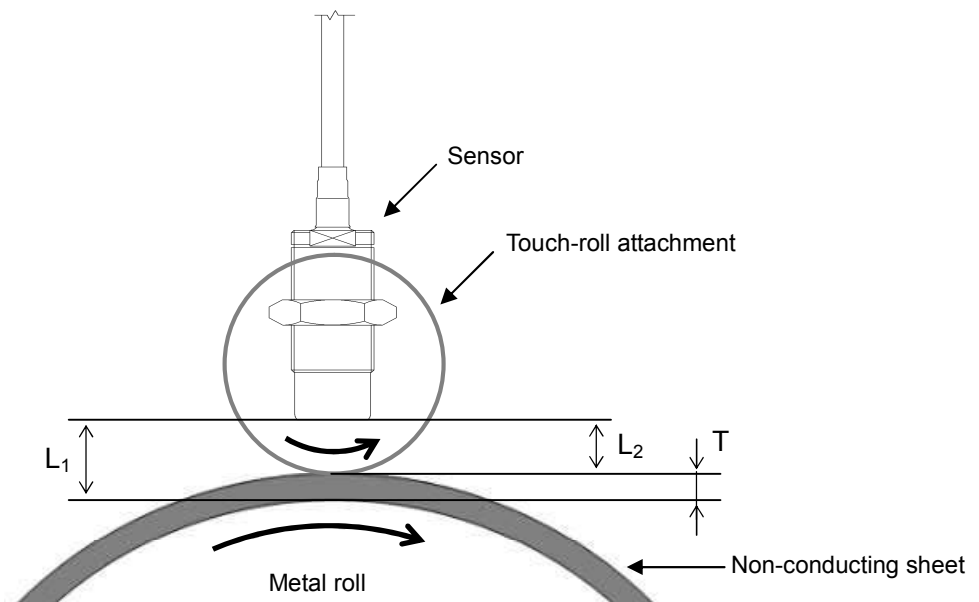

## 2.4 Specifications

### 2.4.1 1 mm range product specification



Model code / Additional spec. code ( No entry if additional spec. code is not specified. )

• Converter

VND -  A -

Thickness measurement range		Converter output	
010	0.0 mm - 1.0 mm	0	Voltage output (0 V - 1 V)
		1	Voltage output (0 V - 5 V)
		2	Voltage output (0 V - 10 V)

• Extension cable (6 m)

NW - 100

Thermocouple	
A	Without
B	With

• Sensor (0.5 m)

NS -

Thickness measurement range		Thermocouple	
020	0.0 mm - 1.0 mm and 0.0 mm - 2.0 mm	A	Without
		B	With

• Touch-roll attachment

NT -  A / AG  /SGL /NWT

Specification		Angle		Swing limit: Horizontal $\pm 15^\circ$	No weight
020	For NS-020 <input type="checkbox"/>	0	0°		
		1	10°		
		2	20°		
		3	30°		
		4	40°		

Configuration

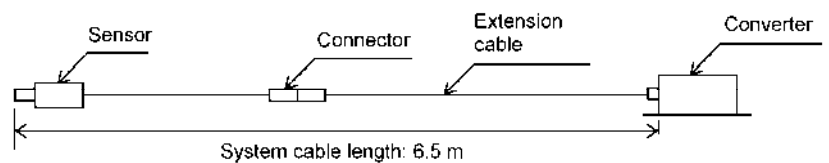
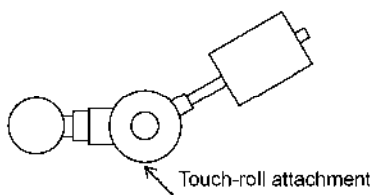

1 mm range product

Specifications		Notice
Converter	VND-010A-□	<p>1. Things to prepare before using this device:                      Four M6 screws or four M6 bolts are required to install the converter.                      For the feeler gauge, a 20% of F.S. pitch (for 6-point adjustment) or a 10% of F.S. pitch (for 11-point adjustment) is required to adjust the device.                      Since the accuracy of the feeler gauge to be used depends on the measurement accuracy, use a gauge which matches the required accuracy.</p> <p>2. Configuration                      Before connecting the sensor, extension cable, and converter, make sure to match the serial numbers indicated on the converter name plate or inspection test report.                      Having the wrong combination of serial numbers may result in specifications not being met.                      When shipping sensor, extension cable or converter alone, we have confirmed the operation in combination with our standard equipment.                      Before use, please calibrate the converter with the combination of the sensor, extension cable and converter that are actually used.                      Please refer to the instruction manual for the calibration method of the converter.                      The temperature characteristics (temperature drift) of the sensor, extension cable or converter when shipped alone are as follows.                      Sensor: ± 2.5% of F.S. (typical),                      Extension cable: ± 2.2% of F.S. (typical),                      Converter: ± 2.2% of F.S. (typical).                      In case of ordering the extension cable alone, please inform us the sensor range information to be used in combination.</p> <p>3. Megger testing of the signal transmission cables that connect to the instrumentation                      After you perform a megger test on the signal transmission cable, make sure to discharge the electrical charge before connecting the cable to the converter.                      Connecting the cable to the converter or the instrumentation while on a charged state may cause a failure</p> <p>4. Sensor installation location                      Do not use the device outdoors where the sensor can be subject to rain water.                      Doing so may cause deterioration of the insulation and alter the sensitivity of the sensor.</p>
Extension cable	NW-100□	
Sensor	NS-020□	
Thickness measurement range	0.0 mm - 1.0 mm (actual gap: 0.8 mm - 1.8 mm)	
Sensor offset gap	0.8 mm	
Calibration material	Chilled steel (flat)	
Output sensitivity	1.0 V/mm, 5.0 V/mm, 10.0 V/mm	
Linearity	±0.5% of F.S. (for 6-point or 11-point adjustment)	
Zero shift range	Approx. ±20% of F.S.	
Resolution	1 μm	
Digital display	5-digit, 7-segment LED (orange) 4-digit thickness display (unit: mm), 1-digit code Accuracy: ±0.005 mm	
Display LED	Power (red) Meas. (green) Teach (green) Cal. Z/S (green)	
Frequency response	DC - 20 Hz (-1 dB typ.)	
Output impedance	100 Ω	
Operating temperature range	Sensor: -30°C to +130°C (Connector part: -25°C to +85°C) Extension cable: -25°C to +85°C Converter: 0°C to +50°C	
Temperature characteristics	Sensor: ±2.5% of F.S. Condition gap: 50% of the thickness measurement range, Target: Chilled steel (flat), Temperature: +25°C is the normal temperature. Range is 0°C to +100°C Extension cable: ±1.5% of F.S. Condition gap: 50% of the thickness measurement range, Target: Chilled steel (flat), Temperature: +25°C is the normal temperature. Range is 0°C to +80°C Converter: ±1.5% of F.S. Condition gap: 50% of the thickness measurement range, Target: Chilled steel (flat), Temperature: +25°C is the normal temperature. Range is 0°C to +50°C	
Operating humidity range	20% to 95% RH (non-condensing, non-immersing)	
Power supply	+24 VDC ±10%, Ripple (p-p) 10% or lower	
Current consumption	Max. of 120 mA	
Terminal block	Terminal block screw size: M3	
Converter part insulation resistance	Between the power supply terminal and the FG terminal: 20 MΩ or higher on 500 VDC	
Converter part withstand voltage	Between the power supply terminal and the FG terminal: 60 Hz on 500 VAC within 1 minute	
Mass	Sensor: Approx. 0.3 kg Extension cable: Approx. 1.3 kg Converter: Approx. 1.0 kg	
Other		

2.4.2 2 mm range product specification



Model code / Additional spec. code ( No entry if additional spec. code is not specified. )

• Converter

VND -  A -

Thickness measurement range		Converter output	
020	0.0 mm - 2.0 mm	0	Voltage output (0 V - 2 V)
		2	Voltage output (0 V - 10 V)

• Extension cable (6 m)

NW - 100

Thermocouple	
A	Without
B	With

• Sensor (0.5 m)

NS -

Thickness measurement range		Thermocouple	
020	0.0 mm - 1.0 mm and 0.0 mm - 2.0 mm	A	Without
		B	With

• Touch-roll attachment

NT -  A / AG  /SGL /NWT

Specification	Angle		Swing limit: Horizontal $\pm 15^\circ$	No weight
	020	For NS-020 <input type="text"/>		
1			10°	
2			20°	
3			30°	
4			40°	

Configuration

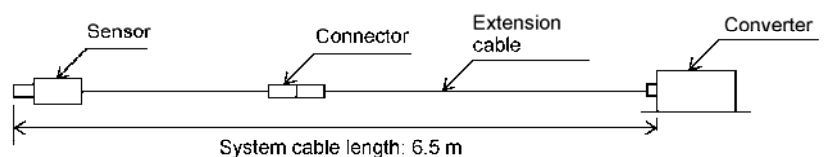
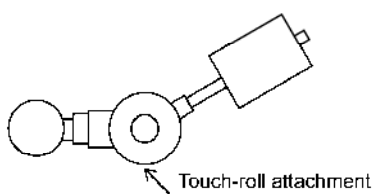

## 2 mm range product

Specifications		Notice
Converter	VND-010A-□	<p>1. Things to prepare before using this device: Four M6 screws or four M6 bolts are required to install the converter. For the feeler gauge, a 20% of F.S. pitch (for 6-point adjustment) or a 10% of F.S. pitch (for 11-point adjustment) is required to adjust the device. Since the accuracy of the feeler gauge to be used depends on the measurement accuracy, use a gauge which matches the required accuracy.</p> <p>2. Configuration Before connecting the sensor, extension cable, and converter, make sure to match the serial numbers indicated on the converter name plate or inspection test report. Having the wrong combination of serial numbers may result in specifications not being met. When shipping sensor, extension cable or converter alone, we have confirmed the operation in combination with our standard equipment. Before use, please calibrate the converter with the combination of the sensor, extension cable and converter that are actually used. Please refer to the instruction manual for the calibration method of the converter. The temperature characteristics (temperature drift) of the sensor, extension cable or converter when shipped alone are as follows. Sensor: ± 2.5% of F.S. (typical), Extension cable: ± 2.2% of F.S. (typical), Converter: ± 2.2% of F.S. (typical). In case of ordering the extension cable alone, please inform us the sensor range information to be used in combination.</p> <p>3. Megger testing of the signal transmission cables that connect to the instrumentation After you perform a megger test on the signal transmission cable, make sure to discharge the electrical charge before connecting the cable to the converter. Connecting the cable to the converter or the instrumentation while on a charged state may cause a failure</p> <p>4. Sensor installation location Do not use the device outdoors where the sensor can be subject to rain water. Doing so may cause deterioration of the insulation and alter the sensitivity of the sensor.</p>
Extension cable	NW-100□	
Sensor	NS-020□	
Thickness measurement range	0.0 mm - 1.0 mm (actual gap: 0.8 mm - 1.8 mm)	
Sensor offset gap	0.8 mm	
Calibration material	Chilled steel (flat)	
Output sensitivity	1.0 V/mm, 5.0 V/mm, 10.0 V/mm	
Linearity	±0.5% of F.S. (for 6-point or 11-point adjustment)	
Zero shift range	Approx. ±20% of F.S.	
Resolution	1 μm	
Digital display	5-digit, 7-segment LED (orange) 4-digit thickness display (unit: mm), 1-digit code Accuracy: ±0.005 mm	
Display LED	Power (red) Meas. (green) Teach (green) Cal. Z/S (green)	
Frequency response	DC - 20 Hz (-1 dB typ.)	
Output impedance	100 Ω	
Operating temperature range	Sensor: -30°C to +130°C (Connector part: -25°C to +85°C) Extension cable: -25°C to +85°C Converter: 0°C to +50°C	
Temperature characteristics	Sensor: ±2.5% of F.S. Condition gap: 50% of the thickness measurement range, Target: Chilled steel (flat), Temperature: +25°C is the normal temperature. Range is 0°C to +100°C Extension cable: ±1.5% of F.S. Condition gap: 50% of the thickness measurement range, Target: Chilled steel (flat), Temperature: +25°C is the normal temperature. Range is 0°C to +80°C Converter: ±1.5% of F.S. Condition gap: 50% of the thickness measurement range, Target: Chilled steel (flat), Temperature: +25°C is the normal temperature. Range is 0°C to +50°C	
Operating humidity range	20% to 95% RH (non-condensing, non-immersing)	
Power supply	+24 VDC ±10%, Ripple (p-p) 10% or lower	
Current consumption	Max. of 120 mA	
Terminal block	Terminal block screw size: M3	
Converter part insulation resistance	Between the power supply terminal and the FG terminal: 20 MΩ or higher on 500 VDC	
Converter part withstand voltage	Between the power supply terminal and the FG terminal: 60 Hz on 500 VAC within 1 minute	
Mass	Sensor: Approx. 0.3 kg Extension cable: Approx. 1.3 kg Converter: Approx. 1.0 kg	
Other		

## 2.5 Dimensions and part names

## 2.5.1 Sensor

NS-020□

Unit: mm

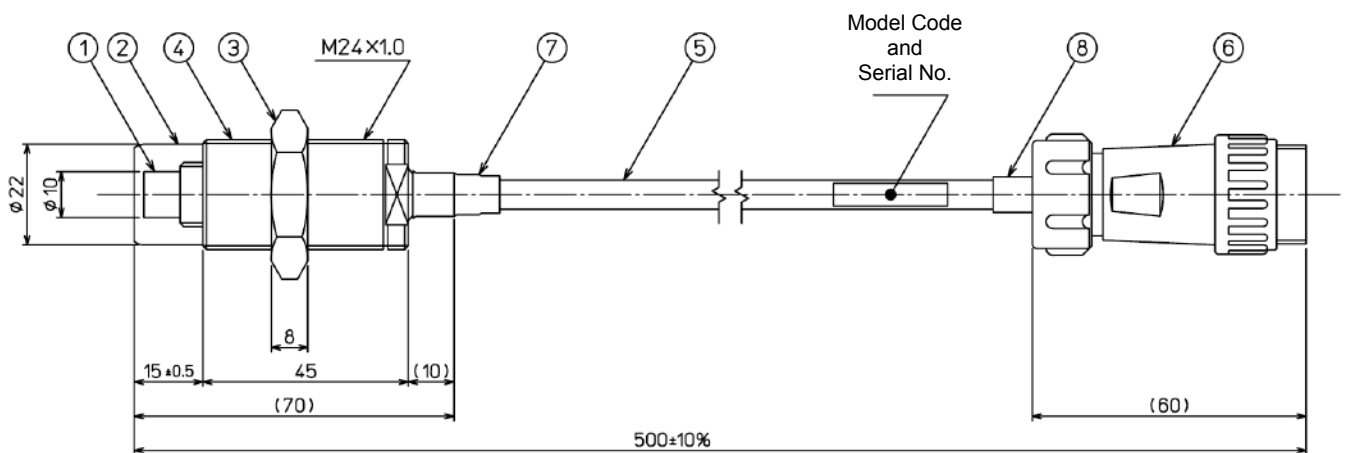

No.	Name	Material	Remarks
1	Sensor tip	Ceramic	-
2	Sensor cover	Glass epoxy	-
3	Jam nut	Stainless steel	-
4	Threaded portion	Stainless steel	-
5	Sensor cable	-	Coated with a heat-shrinkable tubing
6	Connector	-	-
7	Cable protection tube	NBR	-
8	Cable protection tube	NBR	-



## 2.5.2 Extension cable

NW-100A: Without thermocouple

Unit: mm

NW-100B: With thermocouple

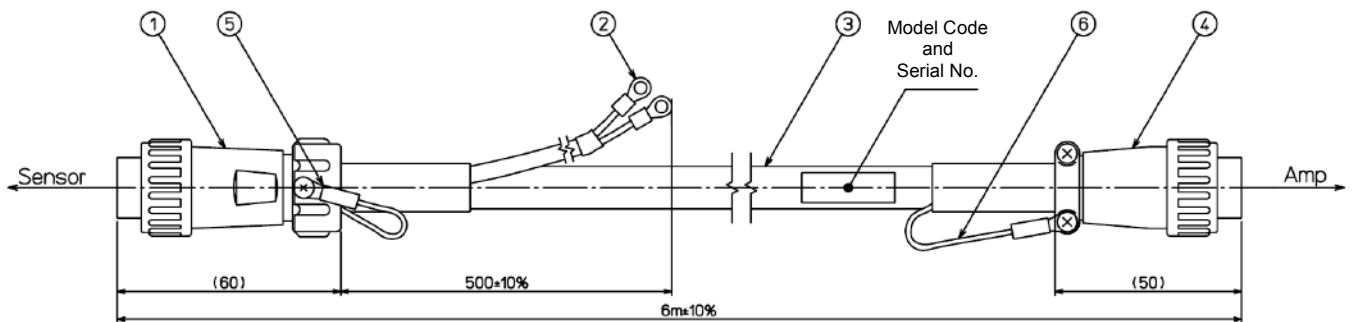

No.	Name	Remarks
1	Connector	Black (sensor side)
2	Thermocouple cable	KX compensating lead wire (CA)
3	Extension cable	-
4	Connector	Silver (converter side)
5	Ground cable	-
6	Ground cable	-

## 2.5.3 Converter

VND-□□□A-□

Unit: mm

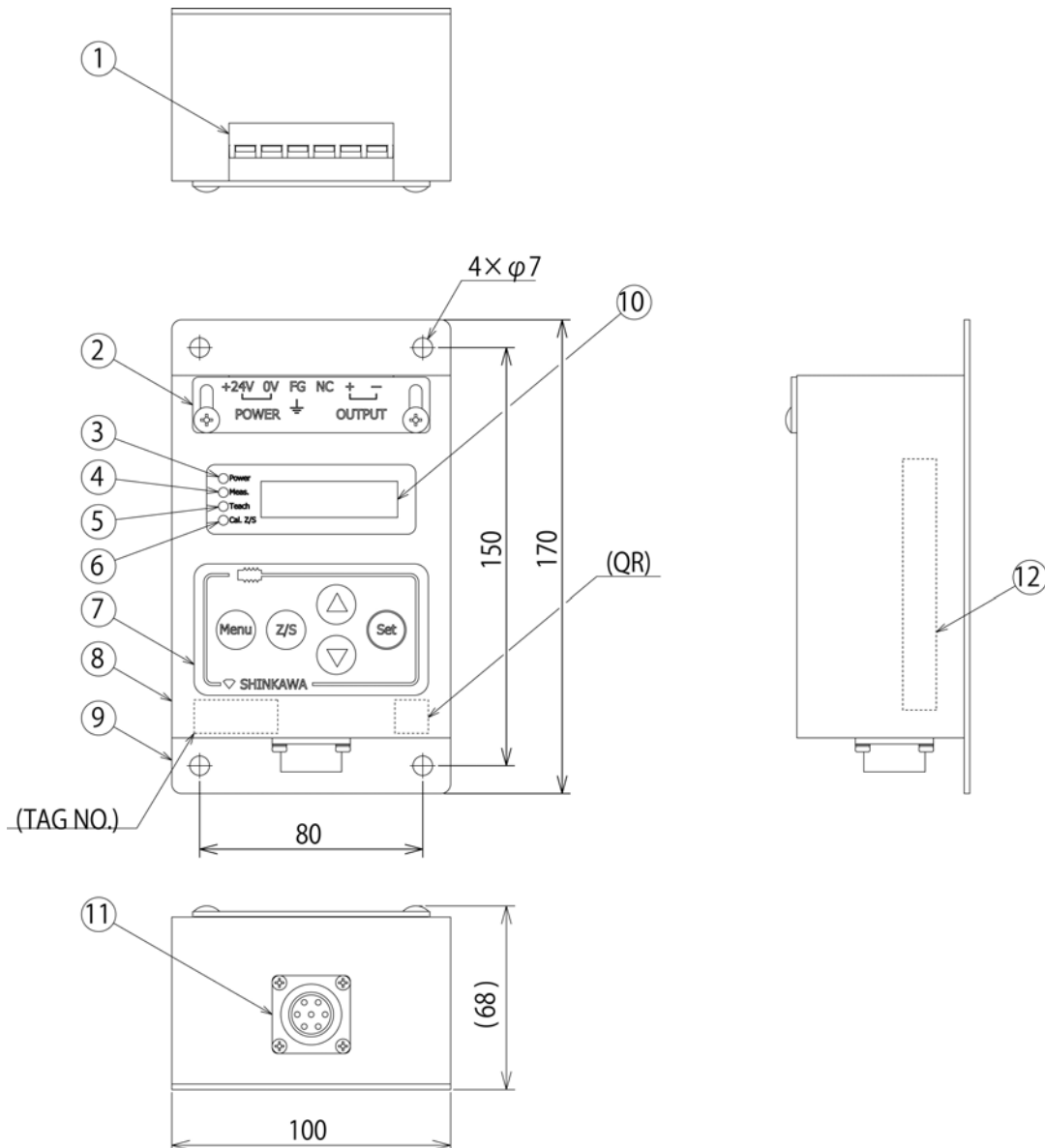

No.	Name	Material	Remarks
1	Terminal block	-	6P M3 screws
2	Terminal cover	Acrylic resin	Fixed M4 screws
3	Power LED	-	Red LED
4	Measurement mode LED (Meas. LED)	-	Green LED
5	Calibration mode LED (Teach LED)	-	Green LED
6	Correction mode LED (Cal. Z/S LED)	-	Green LED
7	Button panel	Polycarbonate, Acrylic resin	-
8	Body	SPCC	Blue
9	Base plate	SPCC	Blue
10	LED display panel	PET	Orange, 7 segment LED, 5 digits
11	Connector	-	Extension cable connection
12	Name plate	-	-

## 2.5.4 Touch-roll attachment

NT-020A

Unit: mm

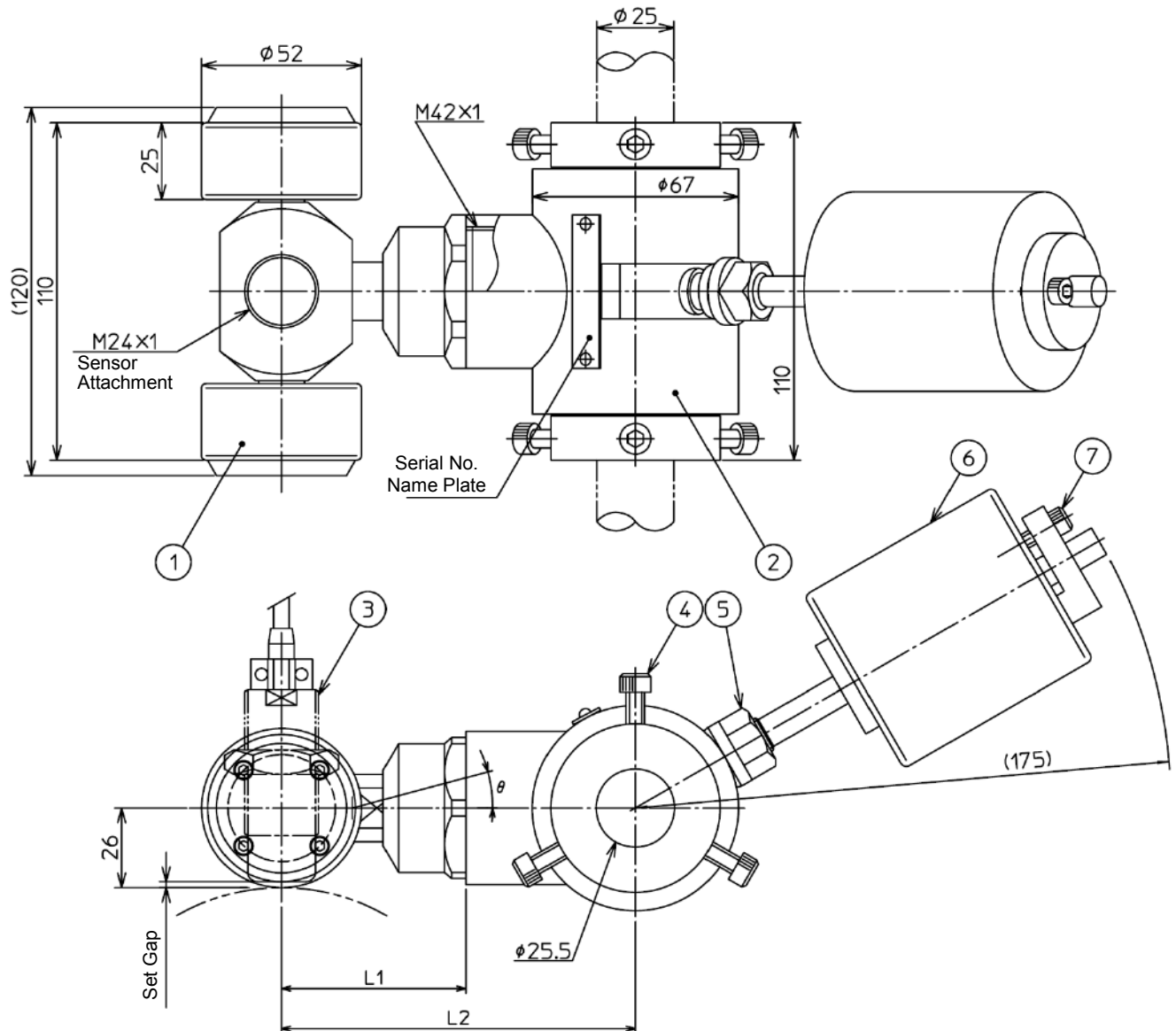

No.	Name	Material	Remarks
1	Roller	-	-
2	Body	Stainless steel	-
3	Sensor	-	-
4	Hex socket head cap bolt	Stainless steel	-
5	Weight angle adjustment nut	Stainless steel	-
6	Weight	Stainless steel	Approx. 2 kg
7	Weight attachment bolt	Stainless steel	-

## 2.6 System configuration

This product uses the following configuration.

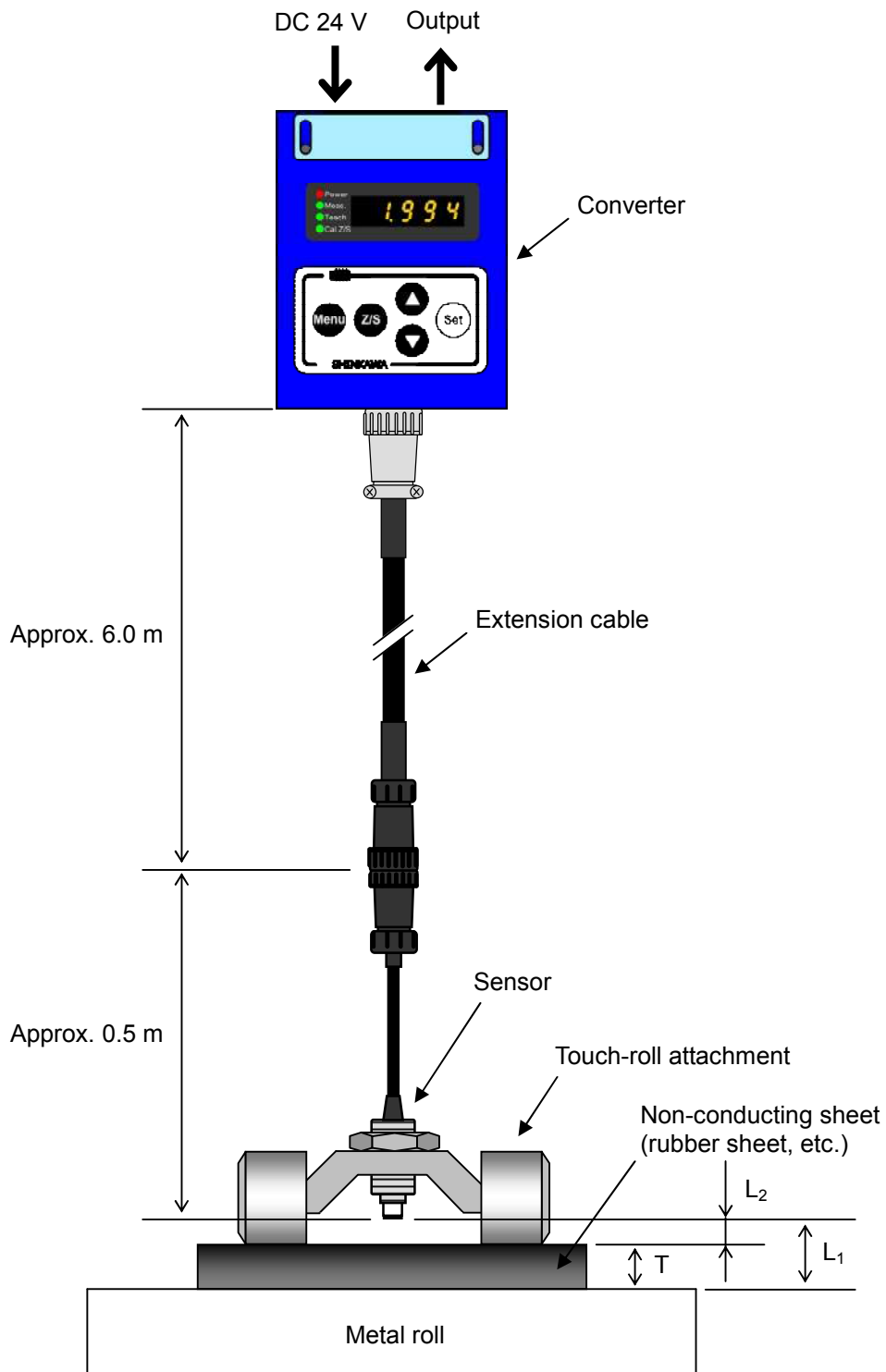

L<sub>1</sub>: Distance to the metal roll from the sensor tip surface

L<sub>2</sub>: Sensor offset gap (0.8 mm)

T: Non-conducting sheet thickness

### 2.6.1 Shape and material of the target

This product is calibrated to have your specified metallic objects (mostly flat chilled steel) as targets. If the shape or material of the target is changed, the specifications of this product may not be met. So in this case, recalibration will be necessary.

### 2.6.2 Configuration

The combination of the sensor, extension cable, and converter in this product is preconfigured at the factory before shipping and has no other interchangeability. Therefore, the product may not meet specifications if used in a combination that is different from the factory default.

When there are multiple displacement sensors, be careful not to have an incorrect combination. In addition, make sure to check the correct combination (Ser. No. combination) by looking at the description on the "inspection test report" attached to the product or the name plate affixed to the converter.

When shipping sensor, extension cable or converter alone, we have confirmed the operation with our standard equipment.

Before use, please calibrate the converter with the combination of the sensor, extension cable and converter that are actually used.

## Chapter 3 Installation

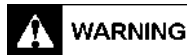

- Installation, wiring, and connection work should be done by a person who has knowledge of the instrumentation.
- Make sure to implement grounding. Also, do not supply electricity to the product until the wiring and connection work are completed. Doing so may increase the risk of electric shock.

### CAUTION

- Before making any contact with the product, make sure to touch metallic objects, etc. to discharge any static electricity.  
Static electricity from the human body may damage the product.
- Check the all wirings if they are connected correctly before turning on the product.  
Otherwise, this may lead to product malfunction or fire.
- Install this product away from motors, relays, and other similar equipment.  
Do not lay the input and output signal cables together with control system cables and power system cables.  
Noise generated due to interference from a relay or motor may cause inaccurate measurements using this product. It is recommended to divide wiring ducts into different groups.
- Do not bend the sensor cable and extension cable or pull them with excessive force. This may cause the conductor within the cables to break.
- After completing installation work, make sure to check the product in its installed condition.

## 3.1 Installation environment

### 3.1.1 Installation environment for the converter

#### ■ Environmental conditions ■

Do not install the converter in:

- Locations that are subject to direct sunlight
- Locations where the ambient temperature exceeds the operating temperature range
- Locations where the ambient humidity exceeds the operating humidity range
- Locations where there is a risk of condensation and steep changes in temperature
- Locations near corrosive or combustible gases
- Locations where there is plenty of dust, salt, or iron
- Locations where the converter is subject to vibrations or shock
- Locations where water, oil, or chemicals can splash on to the product

#### ■ Installation conditions ■

- Use the product while it is fixed in place inside a control panel.
- If there is an obstacle or wall facing the side where the extension cable of the converter is connected, make sure that there is a space of 200 mm or more between the product and the obstacle to prevent the cable from bending unnecessarily, as shown in the figure below.
- If multiple converters are to be installed or if the converter is going to be installed along with other products, maintain a space of at least 30 mm (approximate) around the converter.  
If the ambient temperature exceeds 40°C, it is recommended that you maintain a space of at least 50 mm (approximate) around the converter.

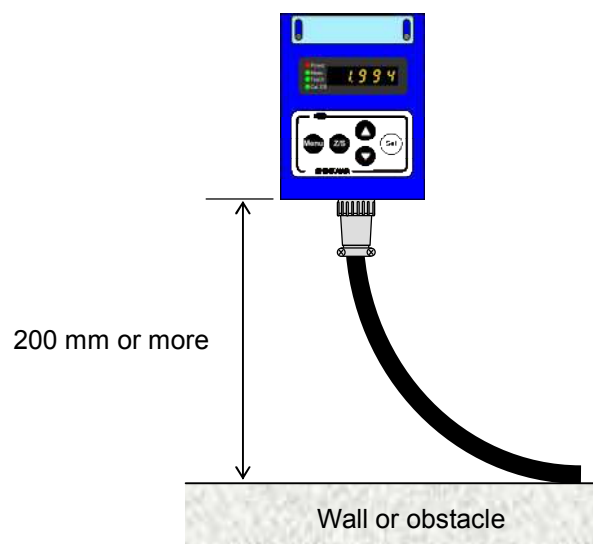

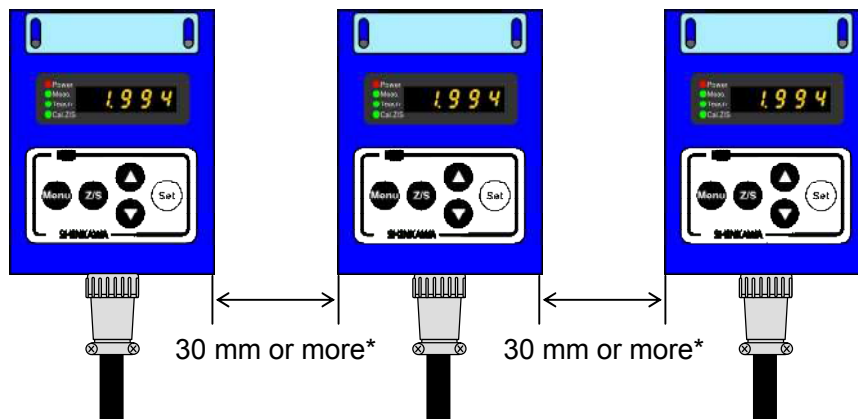

\* If the ambient temperature exceeds 40°C, it is recommended that you maintain a space of at least 50 mm (approximate) around the converter.

### 3.1.2 Installation environment for the sensor

#### ■ Environmental conditions ■

Do not install the sensor in:

- Outdoors where it is subject to rain and water
- Locations where the ambient temperature exceeds the operating temperature range
- Locations where the ambient humidity exceeds the operating humidity range
- Locations near corrosive or combustible gases

#### ■ Installation conditions ■

- Install the sensor so as not to be affected by the pieces of metal other than the target.

Effect of conductors, such as metal around the sensor

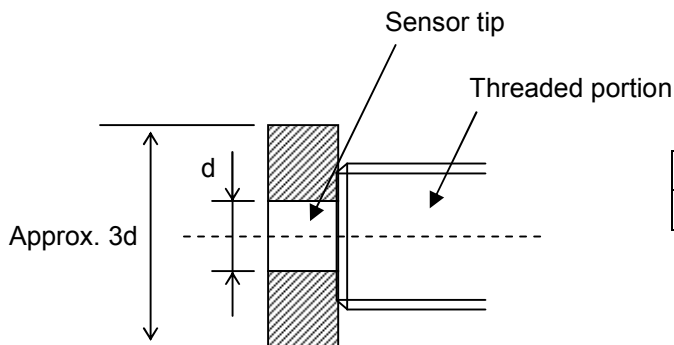

Sensor type	Sensor tip diameter d (mm)
NS-020	φ10

You need to be careful if you are using a jig other than the special attachment since there are cases where performance is decreased if conductors such as metals are present in the portion indicated in the diagram above.



### 3.1.3 Installation environment for the extension cable

#### ■ Environmental conditions ■

Do not install the extension cable in the following locations:

- Locations where the ambient temperature exceeds the operating temperature range
- Locations where the ambient humidity exceeds the operating humidity range
- Locations near corrosive or combustible gases
- Locations where the connector is subject to water or oil

#### ■ Installation conditions ■

- Do not bend the cable continuously or subject it to vibrations.
- Use a clamp to prevent excessive tension.

## 3.2 Installing the converter

Use the product while it is fixed in place inside a control panel.

Attach M6 bolts or M6 screws using the mounting holes at the base plate of the converter.

Please prepare your own mounting screws or bolts.

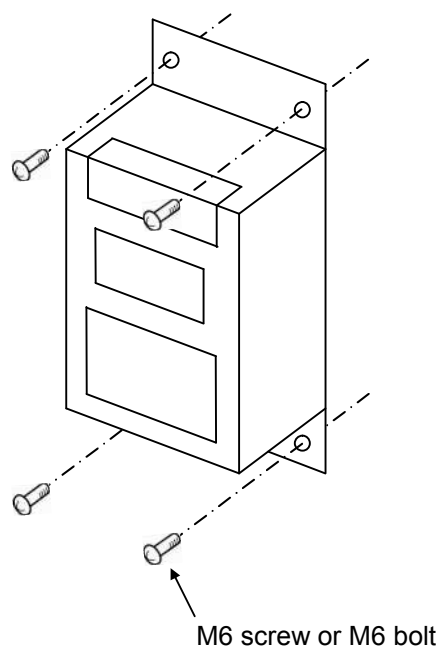

### 3.3 Installing the sensor

#### 3.3.1 When installing the touch-roll attachment

- 1 Remove the sensor cover included with the sensor from the sensor tip.

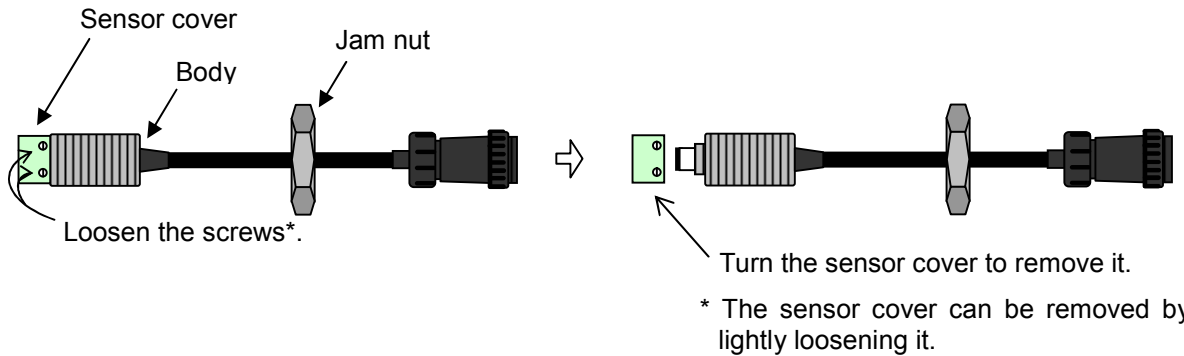

- 2 Push the sensor into the touch-roll attachment.

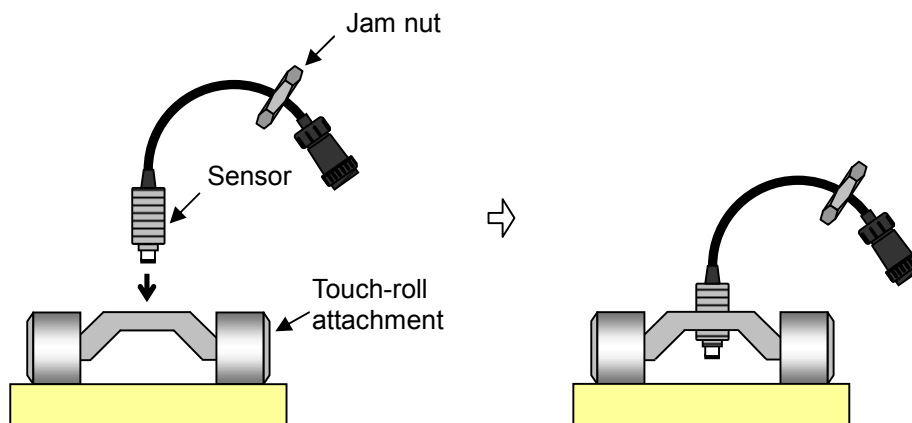

- 3 Insert a 0.8 mm feeler gauge between the sensor tip and the target and adjust the position of the sensor.

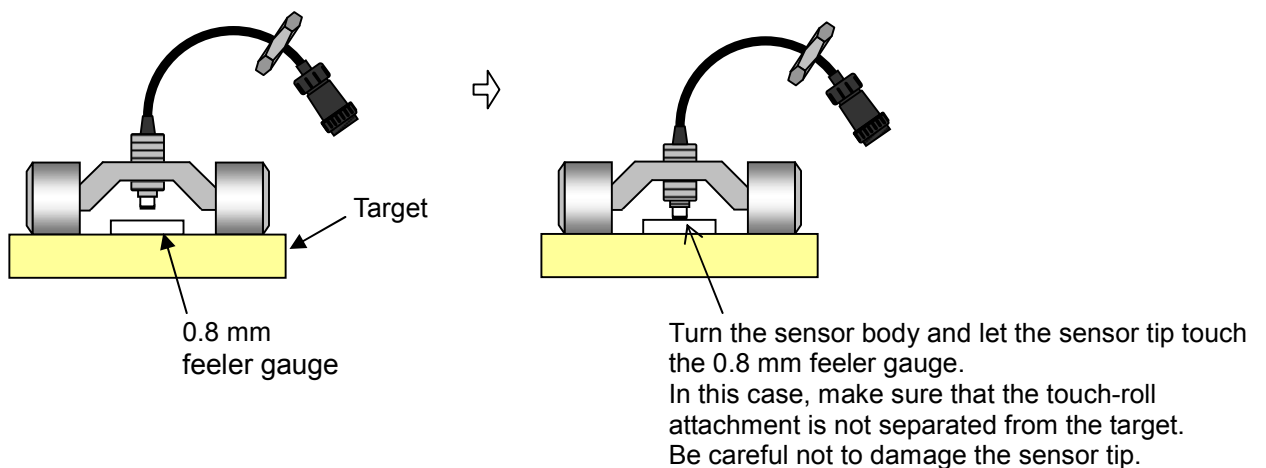

- 4 Fix the sensor in place by tightening the jam nut.

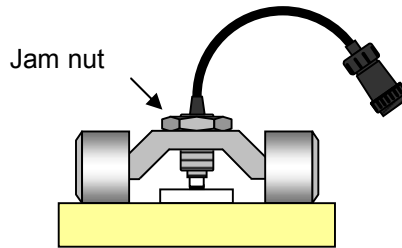

**Point**

Depending on the usage environment of the sensor, tighten the jam nut with a torque of 176 Nm as a standard.

- 5 Remove the feeler gauge between the sensor tip and the target.

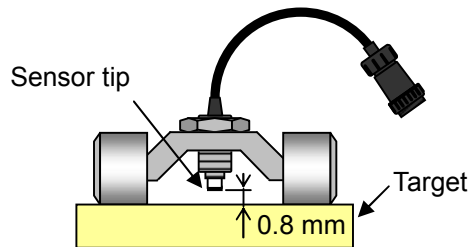

- 6 Lift the touch-roll attachment and attach the sensor cover to the sensor tip.

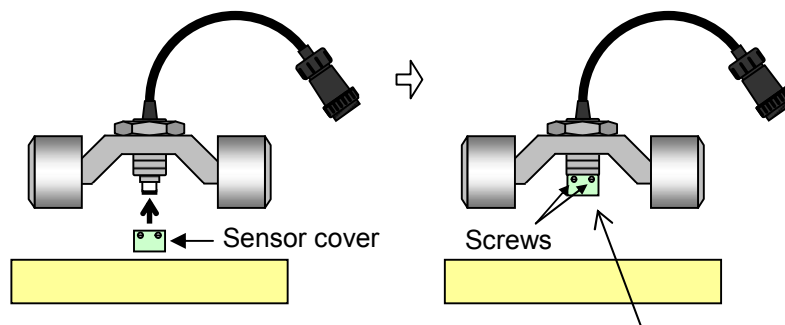

Turn the sensor cover to attach it.  
After attaching the sensor cover, tighten the screws.

- 7 This completes the installation.

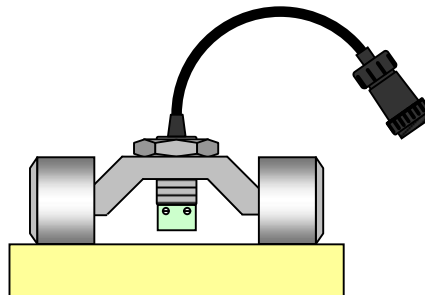

## 3.3.2 When installing a bracket

- 1 Remove the sensor cover included with the sensor from the sensor tip.

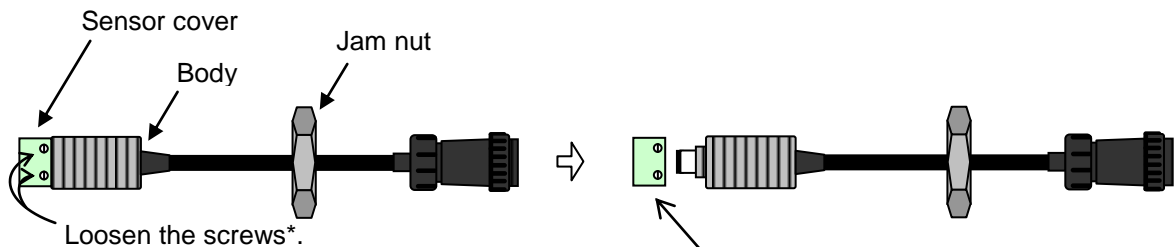

Turn the sensor cover to remove it.

\* The sensor cover can be removed by lightly loosening it.

- 2 Push the bracket into the sensor.

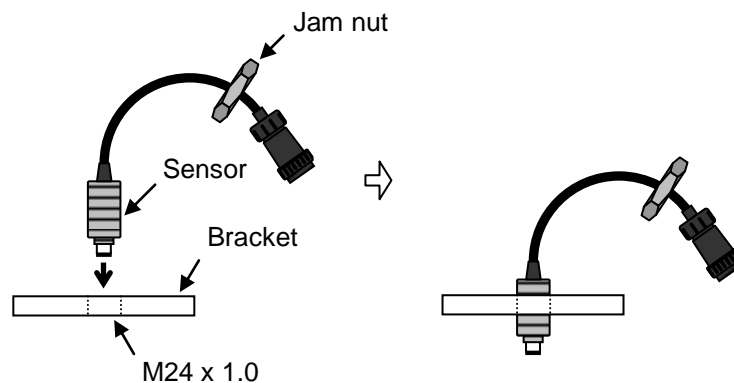

- 3 Insert a 0.8 mm feeler gauge between the sensor tip and the target and adjust the position of the sensor.

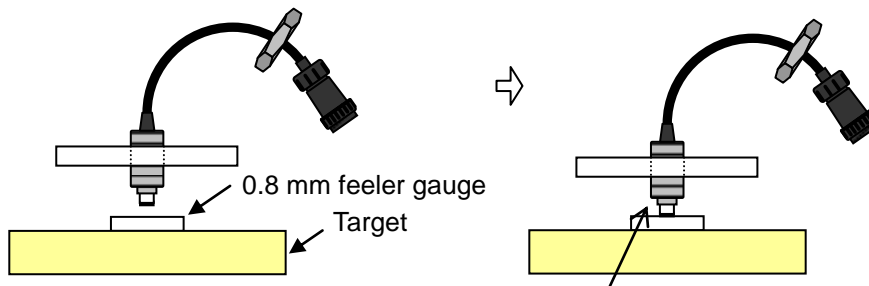

Turn the sensor body and let the sensor tip touch the 0.8 mm feeler gauge. Be careful not to damage the sensor tip.

- 4 Fix the sensor in place by tightening the jam nut.

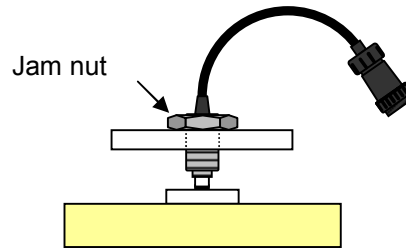

**Point** Depending on the usage environment of the sensor, tighten the jam nut with a torque of 176 Nm as a standard.

- 5 Remove the feeler gauge between the sensor tip and the target.

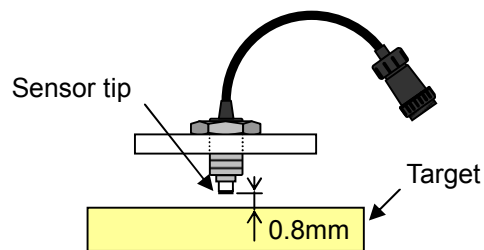

- 6 Attach the sensor cover to the sensor tip.

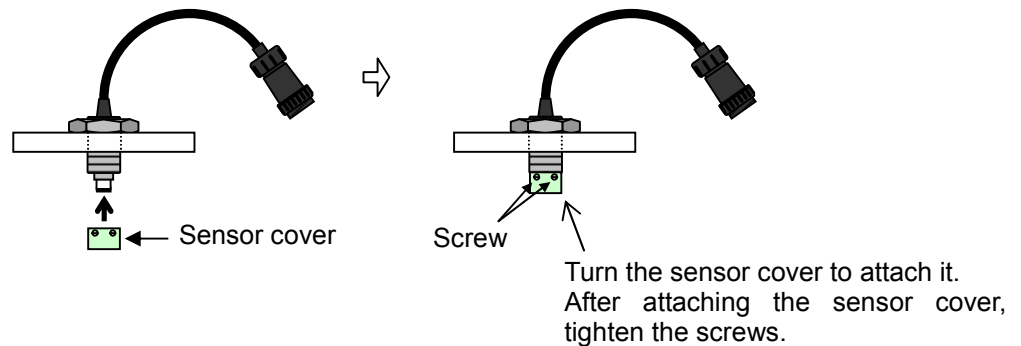

- 7 This completes the installation.

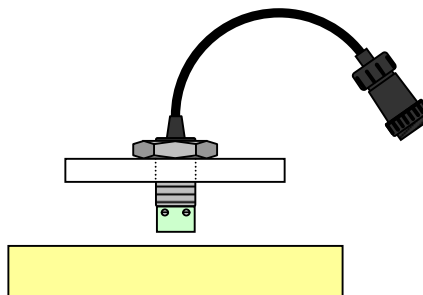

## 3.4 Connections

### 3.4.1 Sensor connection to the converter

Connect the extension cable to the sensor cable connector and the converter connector.

The black connector goes to the sensor side and the silver connector goes to the converter side.

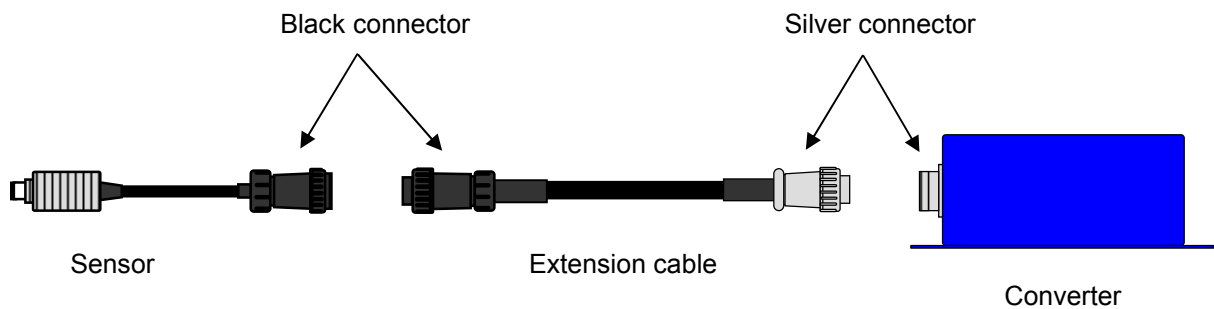

### 3.4.2 Power supply and analog output connections

- Use a M3-size crimped terminal for the connection to each terminal. Use crimped terminals with a width of 7.0 mm or less.
- Connect the power cable (+24 VDC, 0 V) to the +24 V, 0 V terminal in the terminal block POWER part of the converter.
- Connect the converter terminal block's FG terminal to the ground.
- For the OUTPUT terminals (+,-) of the converter terminal block, "+" is the signal and "-" is 0 V. Connect the terminals to the instrumentation.
- NC of the converter terminal block is not used. Do not connect anything to it.
- After connecting to each terminal, protect the terminal block using the terminal cover for safety. The terminal cover can be made to slide.

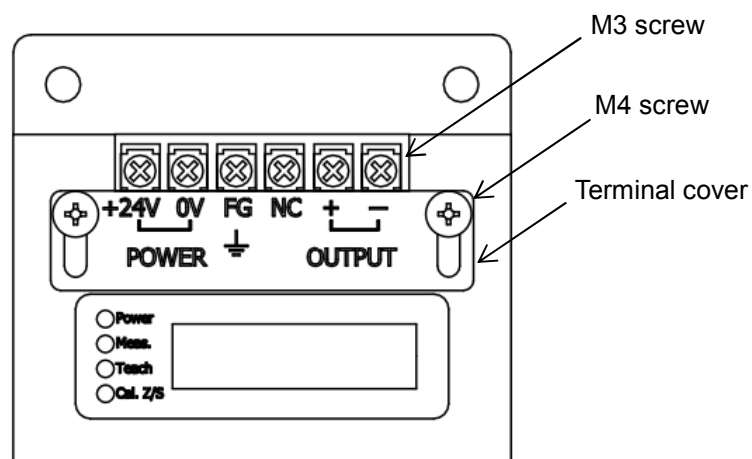

### 3.5 Adjusting the weight position of the touch-roll attachment

#### 3.5.1 Adjusting the weight position

You can change the pressure of the roller part by adjusting the weight position. It is necessary to adjust the pressure of the roller part according to the sheet feed rate, the size of surface irregularities, and the hardness of the sheet.

For example, if the sheet feed rate is high and sheet surface irregularities are large, you should apply the right amount of pressure on the roller part to prevent the roller from jumping out. On the other hand, if the sheet is made of soft material, it is necessary to reduce the pressure so that the roller would not sink into the sheet.

#### 3.5.2 Part names

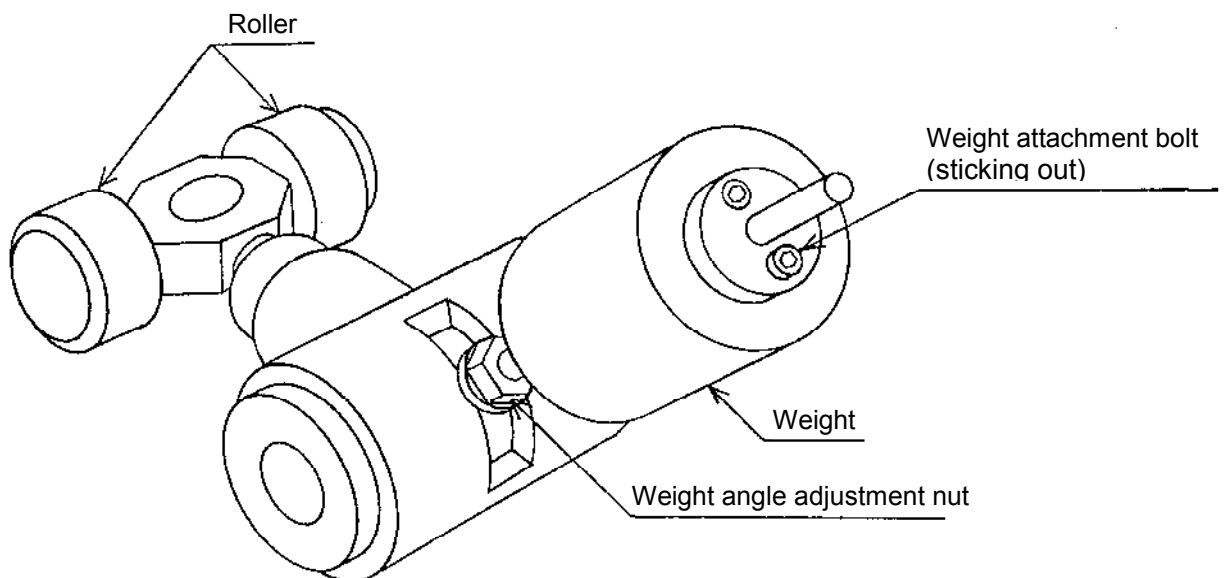

### 3.5.3 Coarse adjustment of the weight position

Loosen the weight attachment bolt to turn the weight and fix it at the center of the axis.

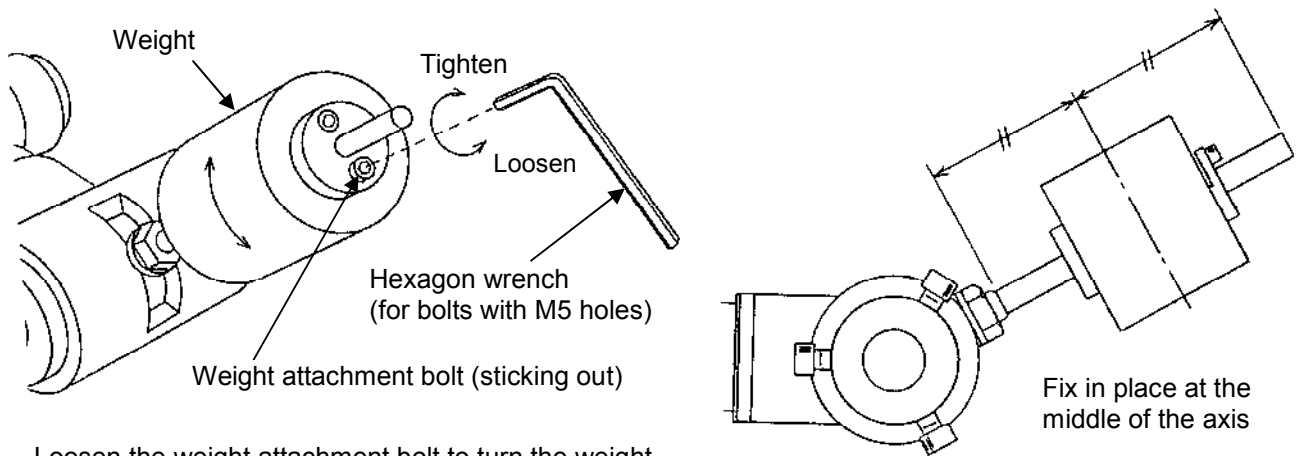

Loosen the weight attachment bolt to turn the weight

Loosen the weight angle adjustment nut to change the weight angle and make a coarse adjustment to the pressure applied to the roller. (Placing the weight in an upright position increases the roller pressure).

After making the adjustment, tighten the weight angle adjustment nut.

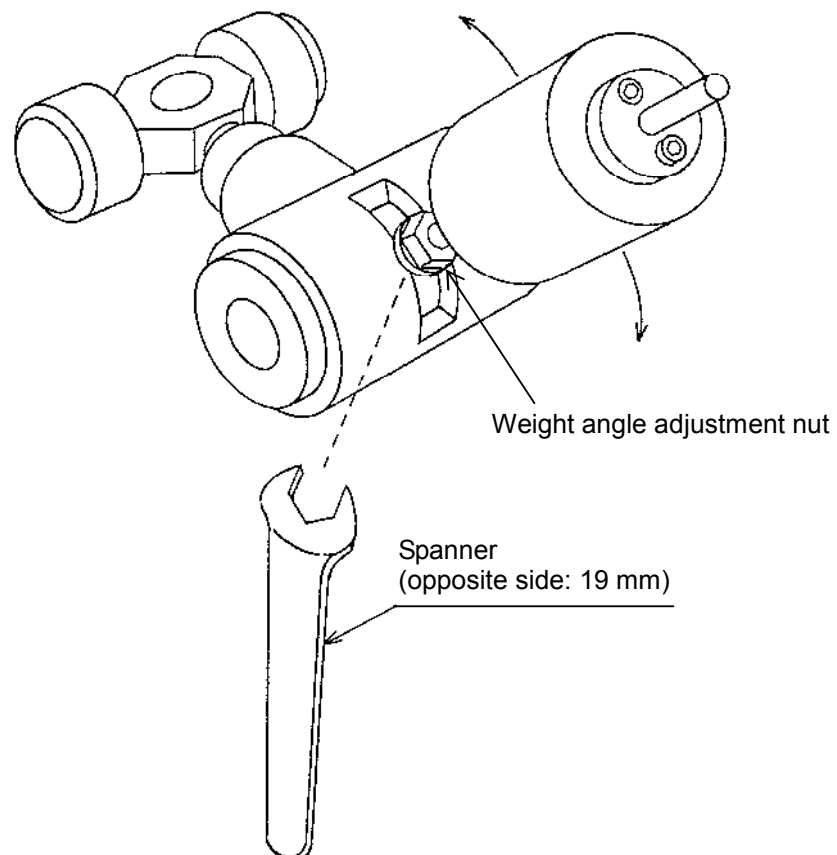



### 3.5.4 Fine adjustment of the weight position

Turn the weight and make a fine adjustment of the pressure applied to the roller. Turning the weight clockwise increases the roller pressure. After making the adjustment, tighten the weight attachment screws.

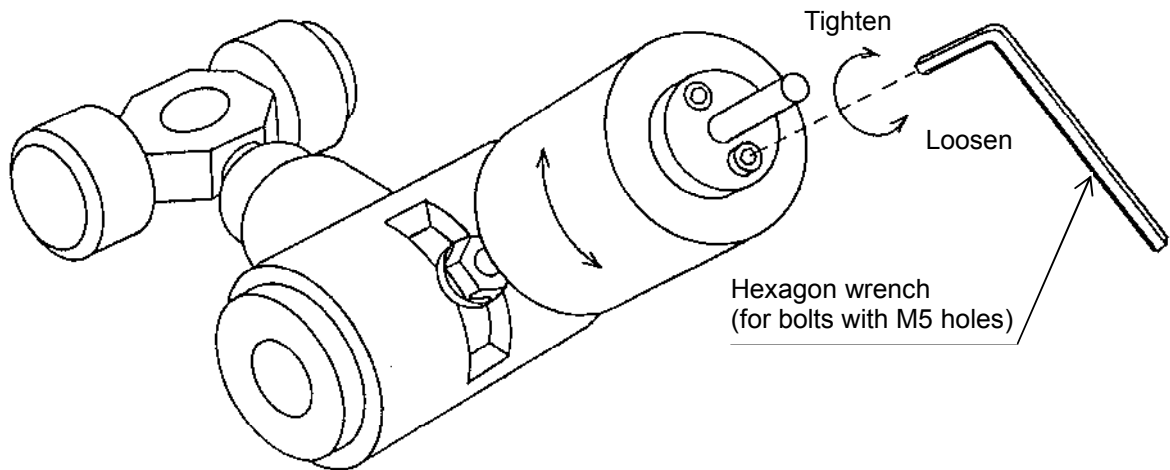

### 3.5.5 Confirming the operation

Perform a thickness measurement on an actual sheet and check the operation.

## Chapter 4 Pre-operation Procedures

### 4.1 Basic use

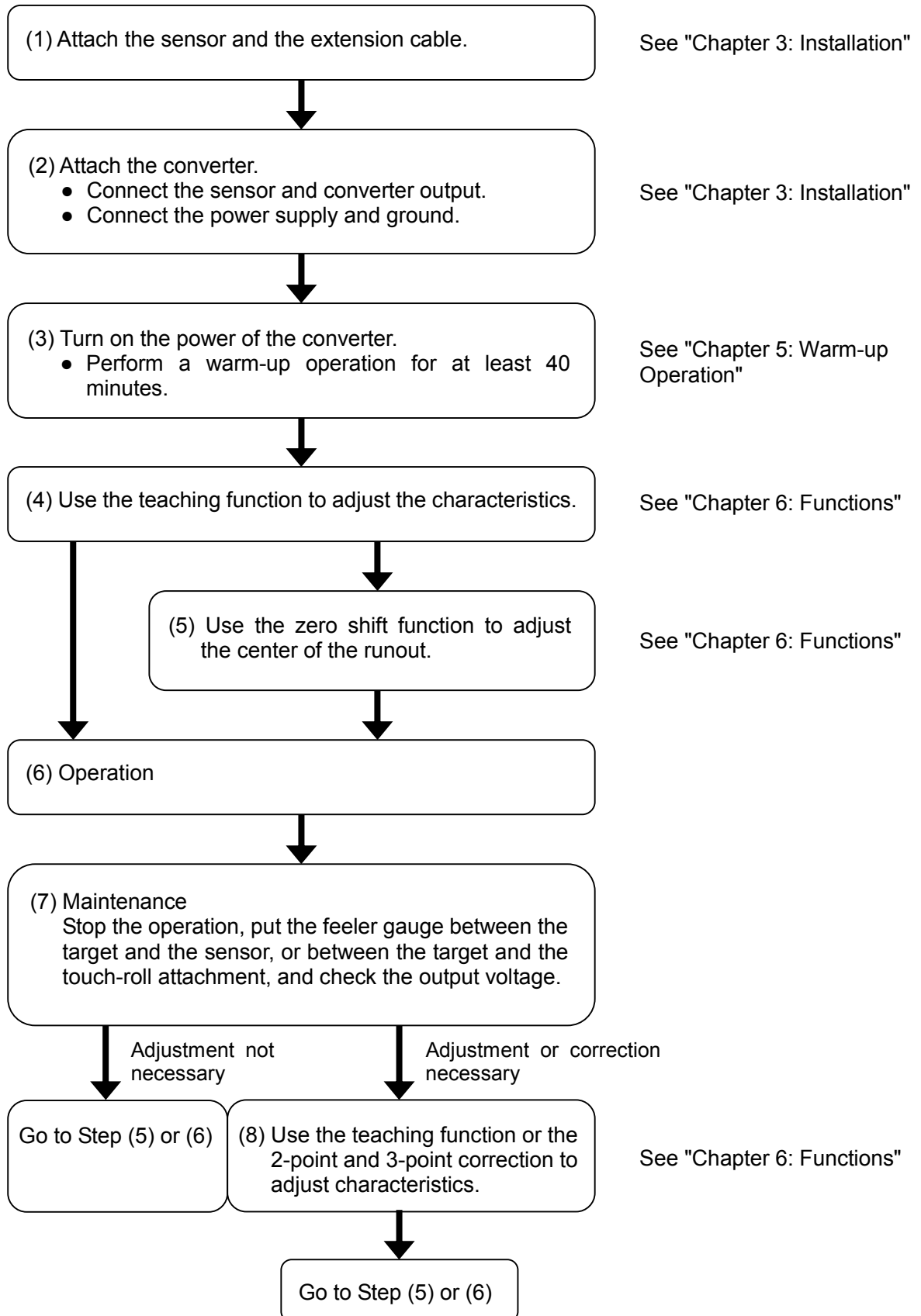

## Chapter 5 Warm-up Operation

---

**CAUTION**

After power-on, perform a warm-up operation for at least 40 minutes. Otherwise, this may result in specifications not being met. Use the product only after the warm-up operation.

---

## Chapter 6 Functions

### 6.1 LED display panel and button panel descriptions

- LED display panel



#### (1) Status display LED

This LED shows these converter statuses: "Power ON/OFF", "Measurement Mode", "Calibration Mode". For details on the display, see "Chapter 7: State Transition Diagrams through Button Operation".

#### (2) Digital display LED

This LED shows the thickness value of the measured object (the unit is mm, and 1 out of the 5 digits indicates a sign) and information that supports the adjustment procedure for the converter.

- Button panel

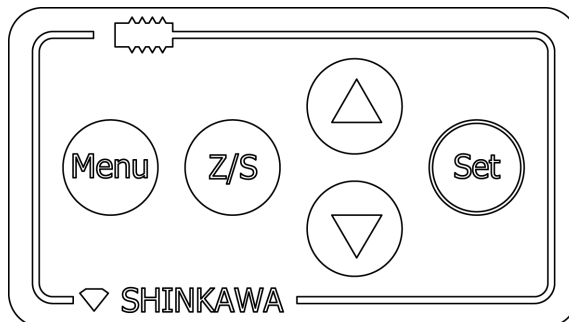

Used for calling various converter functions.



Used for calling the zero shift function.



Used for operating the menu and correcting the zero shift.



Used for executing a function selected from the menu or confirming adjustment/correction information.

## 6.2 Teaching function

This function is an adjustment function used for obtaining high linearity.

Adjustments are made in the range of 0% Gap to 100% Gap using a 20% pitch (6-point teaching) or 10% pitch (11-point teaching) feeler gauge.

**Point** A more precise measurement is possible if the teaching function is used in actual temperature conditions (temperature conditions during operation).

**Point** High linearity accuracy can be obtained using the normal 20% pitch (6-point teaching). However, even higher linearity accuracy can be obtained using 10% pitch (11-point teaching). Select the pitch based on the required accuracy and workability.

---

### CAUTION

Use the main unit reset function before using this function.

Failing to do so will result in improper adjustment.

For details on how to perform the reset operation, see "6.8 Reset function".

---

## 6.3 Using the teaching function

- When using the touch-roll attachment

Insert the feeler gauge in the following places:

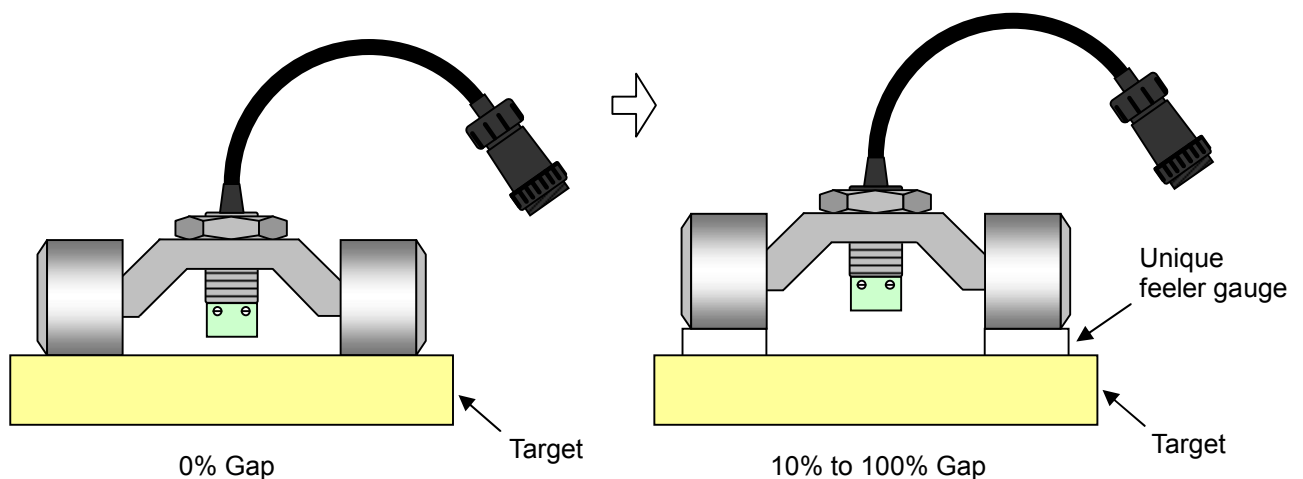

**Point** When the touch-roll attachment is used, you can use not only a non-metallic feeler gauge, but also a feeler gauge made of magnetic or conductive material such as metal.

**CAUTION**

When using a feeler gauge made of magnetic or conductive material such as metal, be careful not to let the feeler gauge get close to the sensor side from the roller part of the touch-roll attachment.

The sensor may detect the feeler gauge which may result in incorrect adjustment.

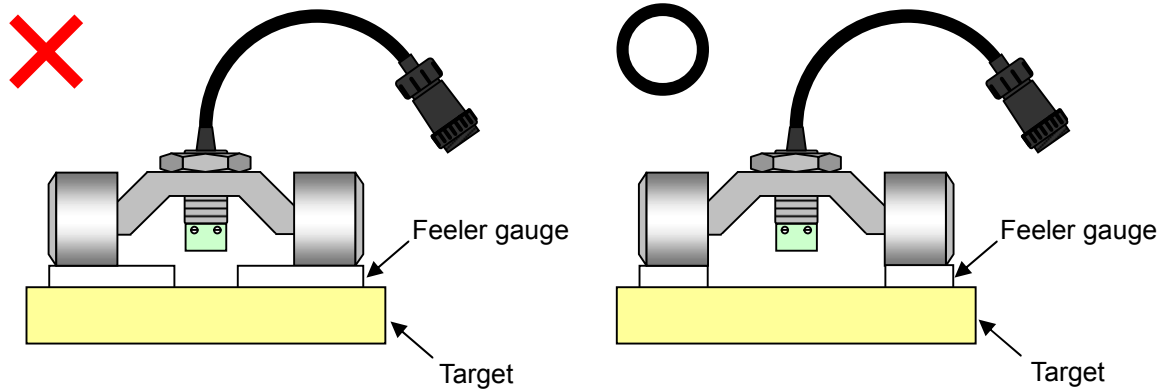

- When making an adjustment by directly placing the feeler gauge on the sensor

A feeler gauge made of magnetic or conductive material such as metal cannot be used in this procedure.

Use a non-metallic feeler gauge instead.

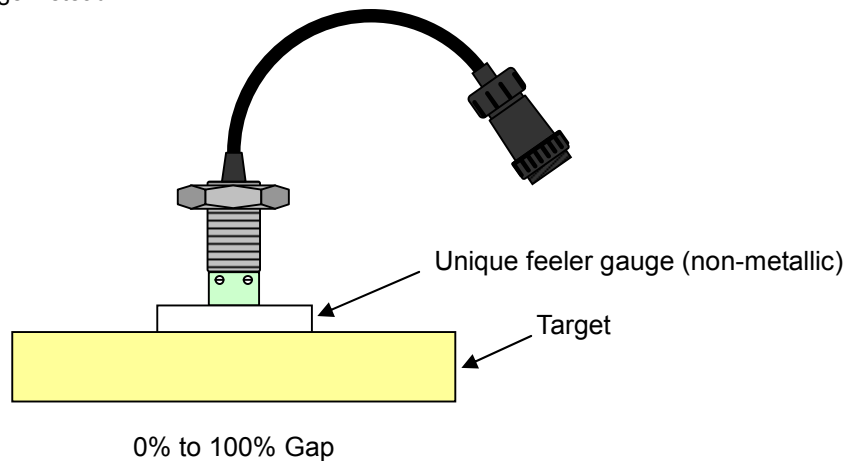
**CAUTION**

Be careful not to apply a strong force on the sensor.

Otherwise, it may damage the sensor.

A feeler gauge made of magnetic or conductive material such as metal cannot be used.

The sensor will detect the feeler gauge which will result in incorrect adjustment.

### 6.3.1 Using the 6-point adjustment function

For the button operation for switching to the calibration mode, see "Chapter 7: State Transition Diagrams through Button Operation".

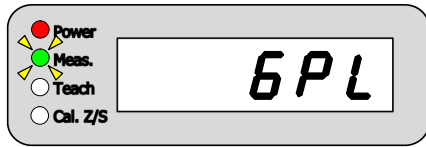

1 Select the 6-point adjustment function from the menu.

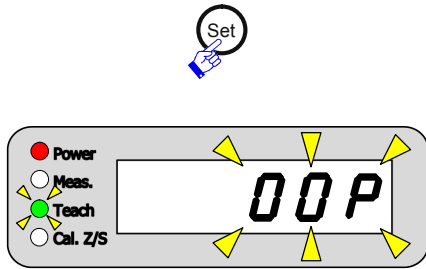

2 The "Teach" LED will flash, and the seven-segment LED display will flash "00P".

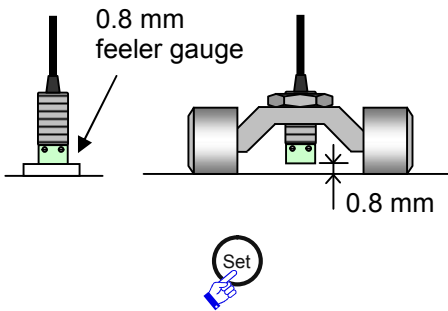

3 Set the sensor gap to 0% and press the "Set" button on the converter.

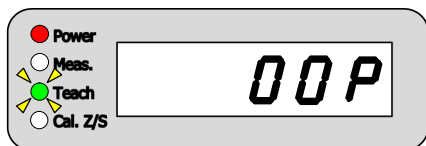

4 The seven-segment LED display will show "00P" (1.5 seconds), and then flash indicate "20P".

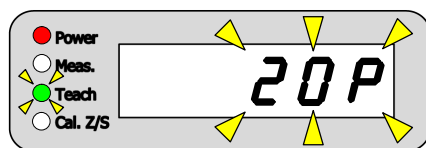

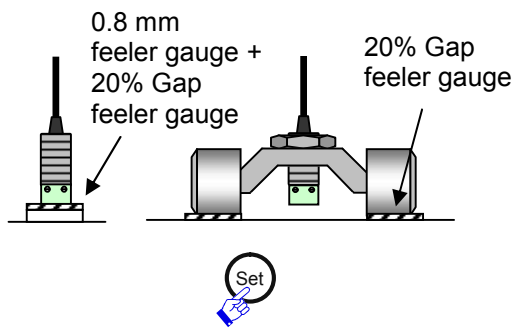

**5** Set the sensor gap to 20% and press the "Set" button on the converter. \*1

\*1 When the sensor gap is 0%



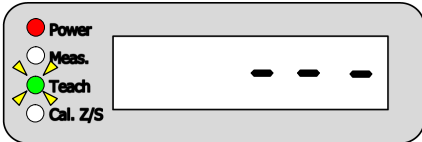

**I** Press the "Set" button on the converter.

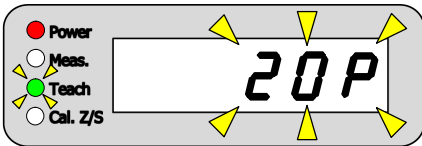

**II** The seven-segment LED display will continuously show " - - -".

**III** The seven-segment LED display will flash indicate "20P".

Insert the correct feeler gauge.

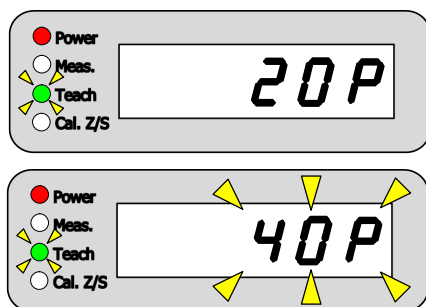

**6** The seven-segment LED display will show "20P" (1.5 seconds), and then flash indicate "40P".



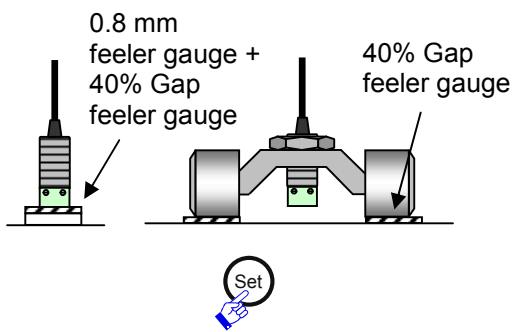

7 Set the sensor gap to 40% and press the "Set" button on the converter. \*2

\*2 When the sensor gap is 0% to 20%



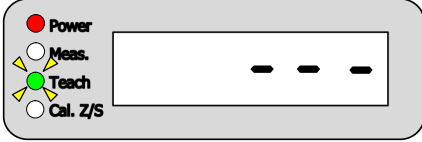

/ Press the "Set" button on the converter.

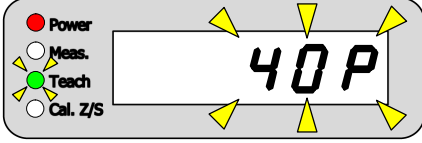

// The seven-segment LED display will continuously show " - - -".

/// The seven-segment LED display will flash indicate "40P".

Insert the correct feeler gauge.

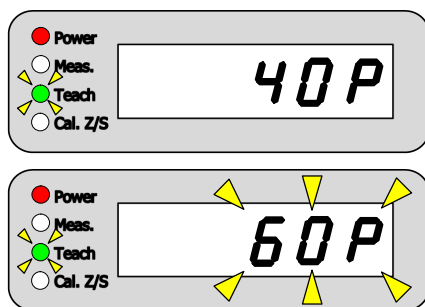

8 The seven-segment LED display will show "40P" (1.5 seconds), and then flash indicate "60P".

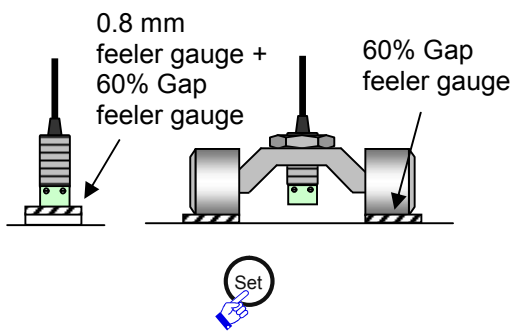

9 Set the sensor gap to 60% and press the "Set" button on the converter. \*3

\*3 When the sensor gap is 0% to 40%



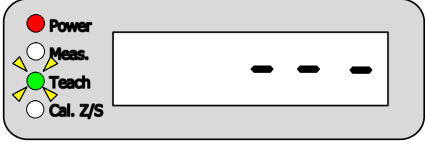
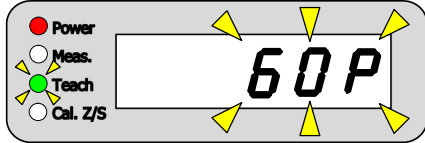



I Press the "Set" button on the converter.

II The seven-segment LED display will continuously show " - - -".

III The seven-segment LED display will flash indicate "60P".

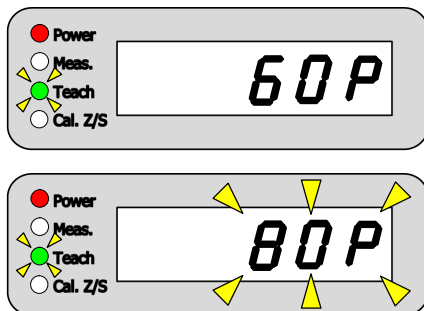
Insert the correct feeler gauge.



10 The seven-segment LED display will show "60P" (1.5 seconds), and then flash indicate "80P".

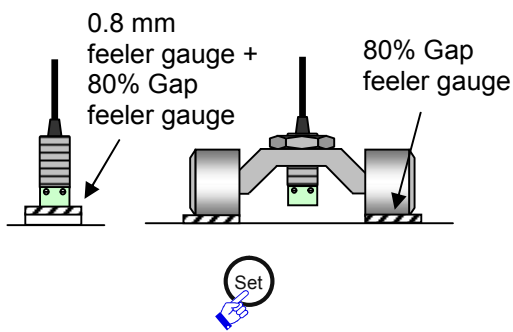

**11** Set the sensor gap to 80% and press the "Set" button on the converter. \*4

\*4 When the sensor gap is 0% to 60%



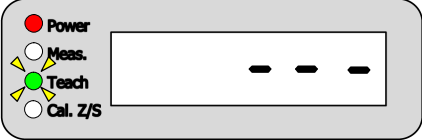

**I** Press the "Set" button on the converter.

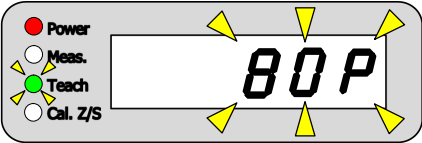

**II** The seven-segment LED display will continuously show " - - -".

**III** The seven-segment LED display will flash indicate "80P".

Insert the correct feeler gauge.

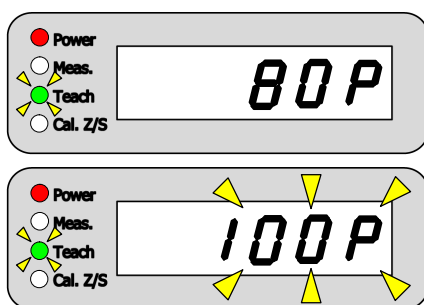

**12** The seven-segment LED display will show "80P" (1.5 seconds), and then flash indicate "100P".

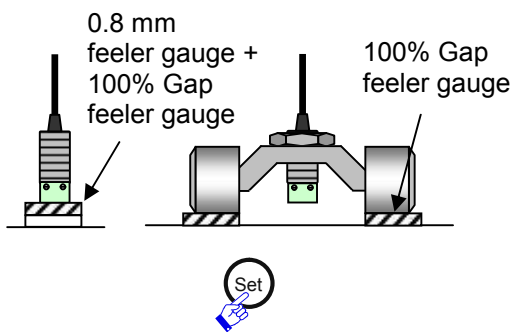

**13** Set the sensor gap to 100% and press the "Set" button on the converter. \*5

\*5 When the sensor gap is 0% to 80%



**I** Press the "Set" button on the converter.

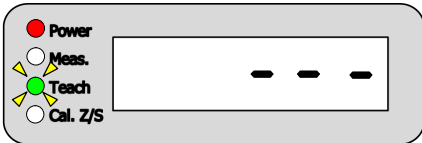

**II** The seven-segment LED display will continuously show " - - -".

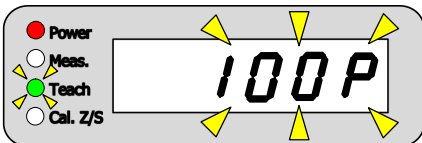

**III** The seven-segment LED display will flash indicate "100P".

Insert the correct feeler gauge.

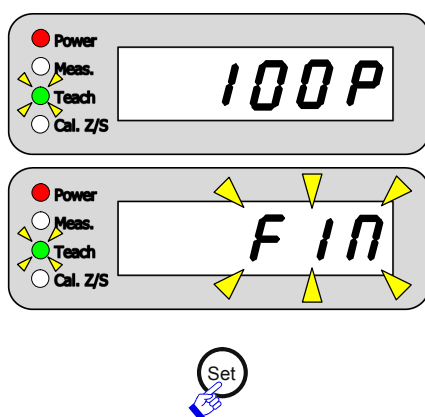

**14** The seven-segment LED display will show "100P" (1.5 seconds), and then flash indicate "FIN".

(Press the converter's "Menu" button to cancel adjustment).

**15** Press the converter's "Set" button to complete adjustment.

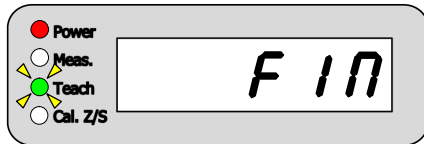

**16** The seven-segment LED display will show "FIN" (1.5 seconds).

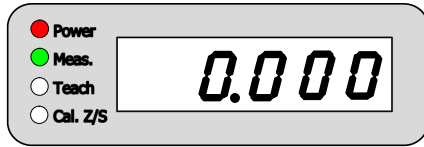

**17** When adjustment is completed, the mode will change to the measurement mode.

The seven-segment LED display will switch to the thickness value.

At the same time, the "Teach" LED will go off then the "Meas." LED will turn on.

Press the converter's "Menu" button to cancel the adjustment procedure at any point from Step **2** to **14**.

## 6.3.2 Using the 11-point adjustment function

For the button operation for switching to the calibration mode, see "Chapter 7: State Transition Diagrams through Button Operation".

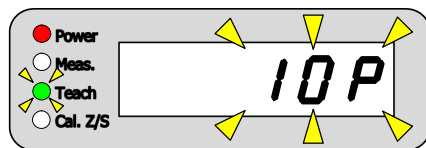
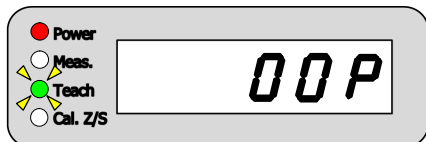
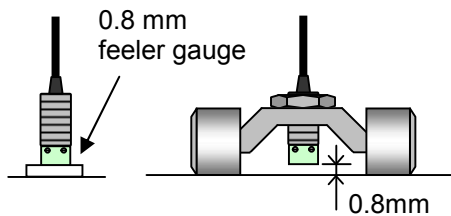
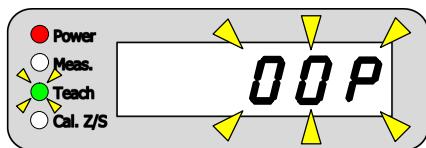
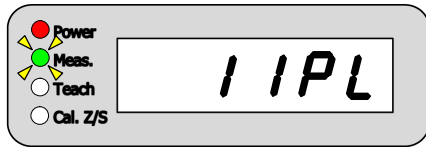

1 Select the 11-point adjustment function from the menu.

2 The "Teach" LED will flash, and the seven-segment LED display will flash "00P".

3 Set the sensor gap to 0% and press the "Set" button on the converter.

4 The seven-segment LED display will show "00P" (1.5 seconds), and then flash indicate "10P".

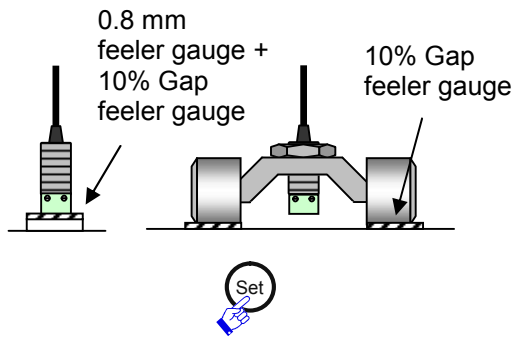

5 Set the sensor gap to 10% and press the "Set" button on the converter. \*6

\*6 When the sensor gap is 0%



/ Press the "Set" button on the converter.

● Power

○ Meas.

● Teach

○ Cal. Z/S

---

// The seven-segment LED display will continuously show " - - -".

● Power

○ Meas.

● Teach

○ Cal. Z/S

10P

/// The seven-segment LED display will flash indicate "10P".

Insert the correct feeler gauge.

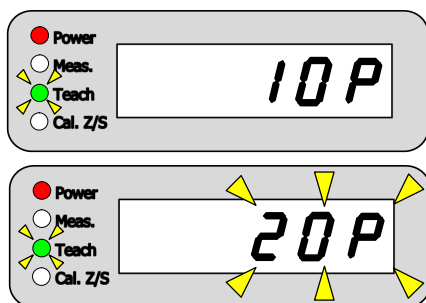

6 The seven-segment LED display will show "10P" (1.5 seconds), and then flash indicate "20P".

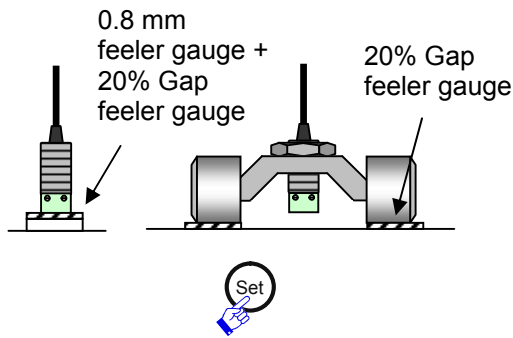

7 Set the sensor gap to 20% and press the "Set" button on the converter. \*7

\*7 When the sensor gap is 0% to 10%



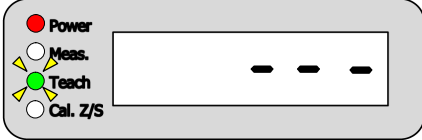

/ Press the "Set" button on the converter.

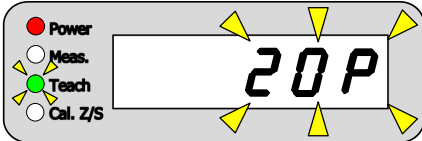

// The seven-segment LED display will continuously show " - - -".

/// The seven-segment LED display will flash indicate "20P".

Insert the correct feeler gauge.

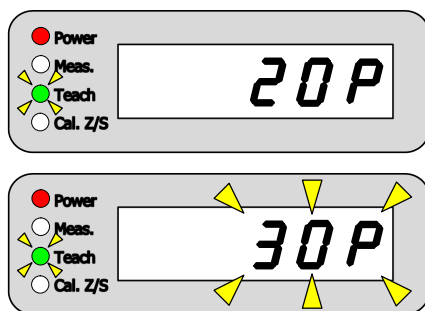

8 The seven-segment LED display will show "20P" (1.5 seconds), and then flash indicate "30P".



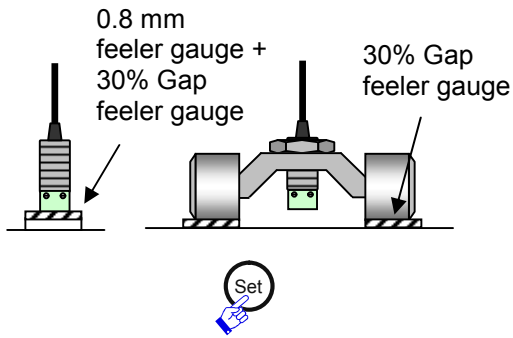

9 Set the sensor gap to 30% and press the "Set" button on the converter. \*8

\*8 When the sensor gap is 0% to 20%



I Press the "Set" button on the converter.

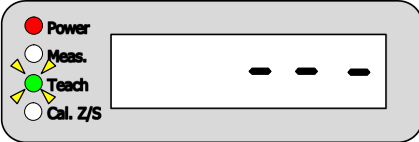

II The seven-segment LED display will continuously show " - - -".

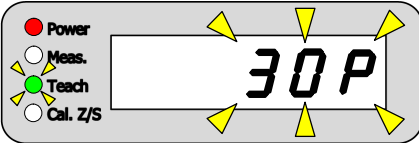

III The seven-segment LED display will flash indicate "30P".  
Insert the correct feeler gauge.

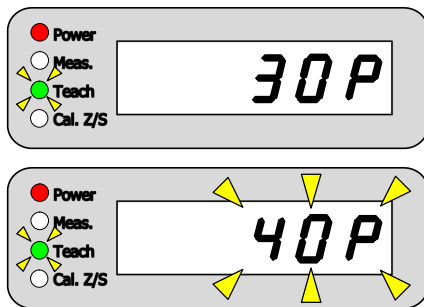

10 The seven-segment LED display will show "30P" (1.5 seconds), and then flash indicate "40P".

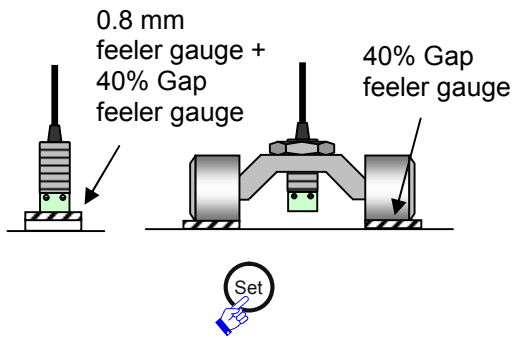

**11** Set the sensor gap to 40% and press the "Set" button on the converter. \*9

\*9 When the sensor gap is 0% to 30%



**I** Press the "Set" button on the converter.

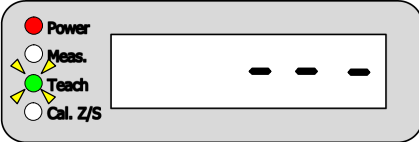

**II** The seven-segment LED display will continuously show " - - -".

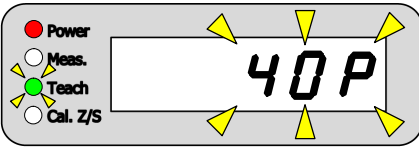

**III** The seven-segment LED display will flash indicate "40P".  
Insert the correct feeler gauge.

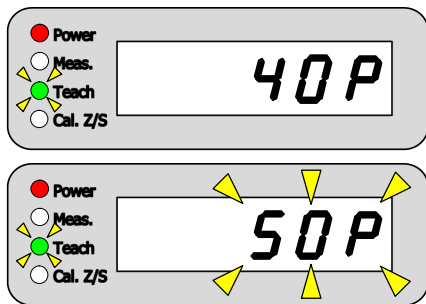

**12** The seven-segment LED display will show "40P" (1.5 seconds), and then flash indicate "50P".

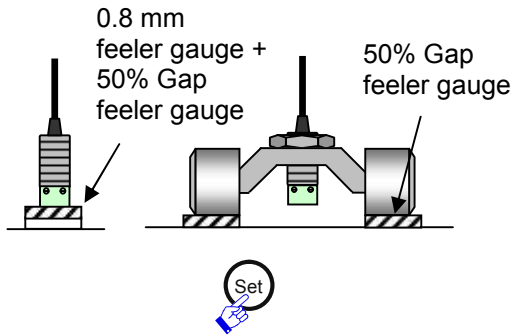

**13** Set the sensor gap to 50% and press the "Set" button on the converter. \*10

\*10 When the sensor gap is 0% to 40%



**I** Press the "Set" button on the converter.

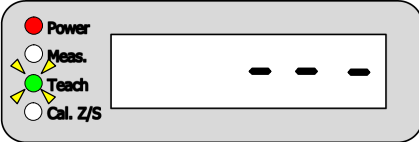

**II** The seven-segment LED display will continuously show " - - -".

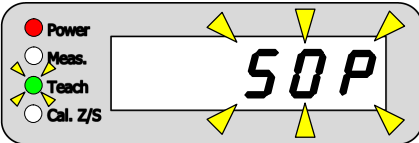

**III** The seven-segment LED display will flash indicate "50P".  
Insert the correct feeler gauge.

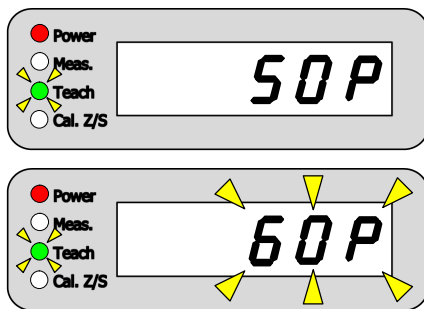

**14** The seven-segment LED display will show "50P" (1.5 seconds), and then flash indicate "60P".

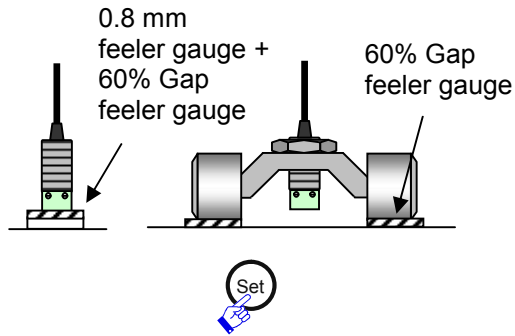

**15** Set the sensor gap to 60% and press the "Set" button on the converter. \*11

\*11 When the sensor gap is 0% to 50%

Set

Power Meas. Teach Cal. Z/S

---

Press the "Set" button on the converter.

The seven-segment LED display will continuously show " - - -".

60P

The seven-segment LED display will flash indicate "60P".

Insert the correct feeler gauge.

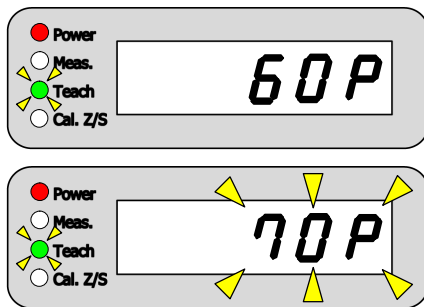

**16** The seven-segment LED display will show "60P" (1.5 seconds), and then flash indicate "70P".

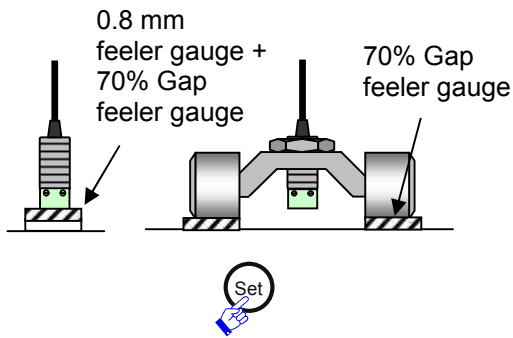

**17** Set the sensor gap to 70% and press the "Set" button on the converter. <sup>\*12</sup>

\*12 When the sensor gap is 0% to 60%



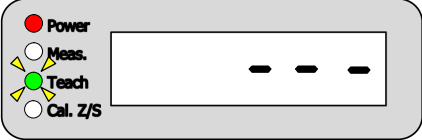

**I** Press the "Set" button on the converter.

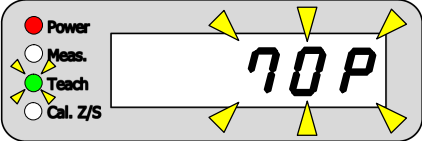

**II** The seven-segment LED display will continuously show " - - -".

**III** The seven-segment LED display will flash indicate "70P".

Insert the correct feeler gauge.

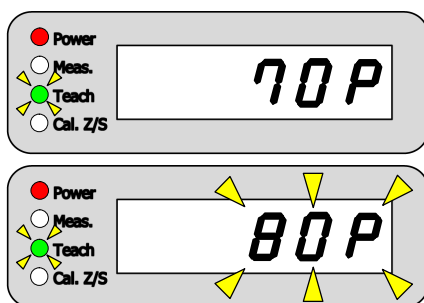

**18** The seven-segment LED display will show "70P" (1.5 seconds), and then flash indicate "80P".

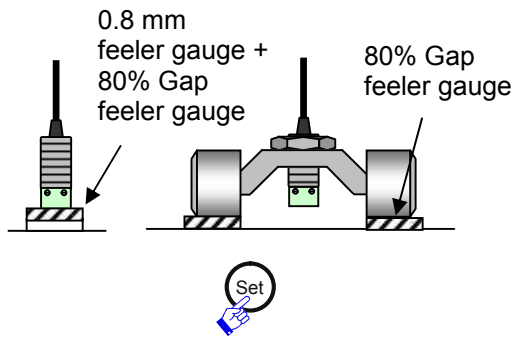

**19** Set the sensor gap to 80% and press the "Set" button on the converter. <sup>\*13</sup>

\*13 When the sensor gap is 0% to 70%



**I** Press the "Set" button on the converter.

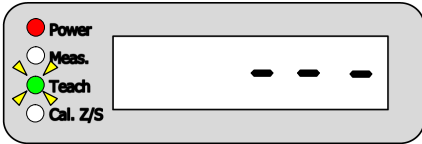

**II** The seven-segment LED display will continuously show " - - -".

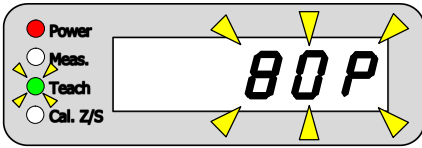

**III** The seven-segment LED display will flash indicate "80P".  
Insert the correct feeler gauge.

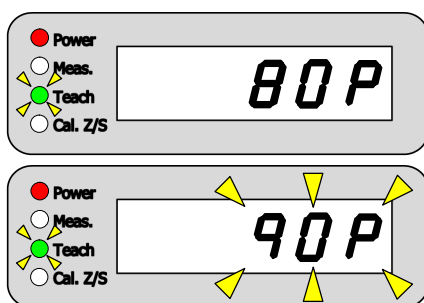

**20** The seven-segment LED display will show "80P" (1.5 seconds), and then flash indicate "90P".

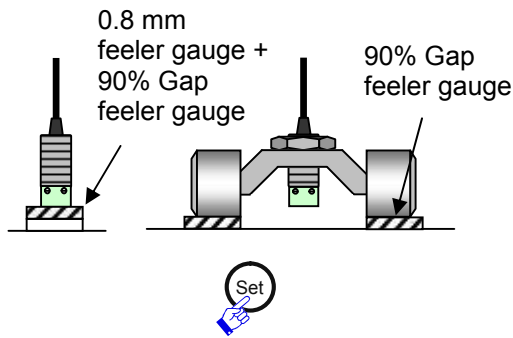

**21** Set the sensor gap to 90% and press the "Set" button on the converter. \*14

\*14 When the sensor gap is 0% to 80%



**I** Press the "Set" button on the converter.

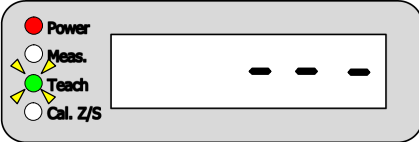

**II** The seven-segment LED display will continuously show " - - -".

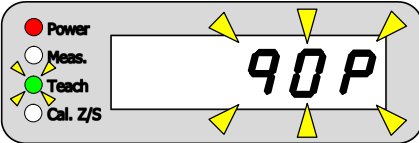

**III** The seven-segment LED display will flash indicate "90P".  
Insert the correct feeler gauge.

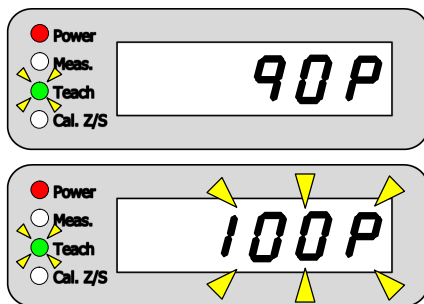

**22** The seven-segment LED display will show "90P" (1.5 seconds), and then flash indicate "100P".

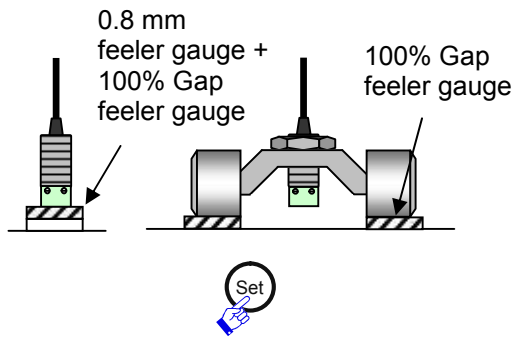

**23** Set the sensor gap to 100% and press the "Set" button on the converter. <sup>\*15</sup>

\*15 When the sensor gap is 0% to 90%

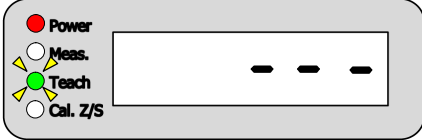
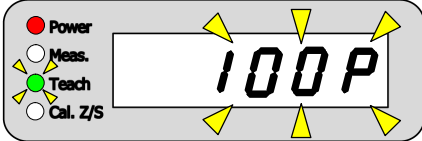

**I** Press the "Set" button on the converter.

**II** The seven-segment LED display will continuously show " - - -".

**III** The seven-segment LED display will flash indicate "100P".  
Insert the correct feeler gauge.

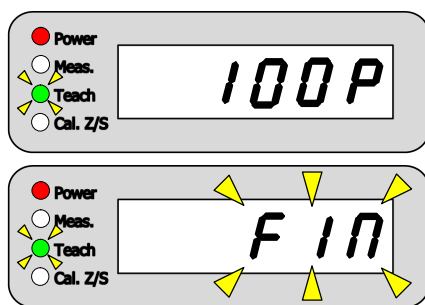

**24** The seven-segment LED display will show "100P" (1.5 seconds), and then flash indicate "FIN".

(Press the converter's "Menu" button to cancel adjustment).



**25** Press the converter's "Set" button to complete adjustment.



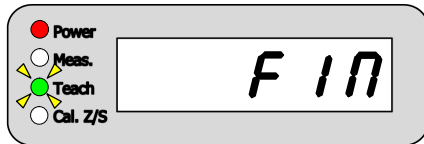

**26** The seven-segment LED display will show "FIN" (1.5 seconds).



**27** When adjustment is completed, the mode will change to the measurement mode.

The seven-segment LED display will switch to the thickness value.

At the same time, the "Teach" LED will go off then the "Meas." LED will turn on.

Press the converter's "Menu" button to cancel the adjustment procedure at any point from Step **2** to **24**.

## 6.4 Zero shift function

This function is used when the converter output of the 0% gap and 100% gap point is shifted in the same direction. It shifts the output while maintaining high linearity.

This function is also used when you want to set the center of the runout during metal roll rotation (during operation) to 0 V.

## 6.5 Using the zero shift function

For the button operation for switching to the calibration mode, see "Chapter 7: State Transition Diagrams through Button Operation".

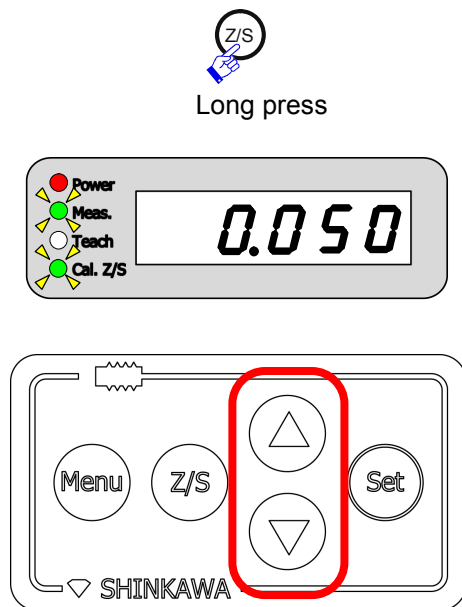

1 Press and hold the "Z/S" button to select the zero shift function.

2 The "Meas." and "Cal. Z/S" LEDs will flash.

3 Press the " $\Delta$ " or " $\nabla$ " buttons to adjust the amount of zero shift.

The thickness display value is linked to this adjustment. <sup>\*1</sup>

If there is no button operation for one minute from the last operation of the " $\Delta$ " or " $\nabla$ " buttons, the current adjustment value will automatically be applied and the mode will change to the measurement mode.

4 Press the "Set" button to complete the zero shift correction.

5 The "Cal. Z/S" LED will go off, the "Meas." LED will turn on, and the mode will change to the measurement mode.

Press the converter's "Menu" button to cancel the correction procedure at any point from Step 2 to 3.

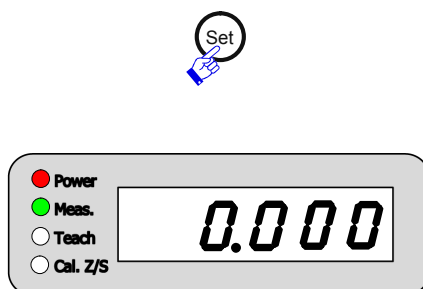

\* 1

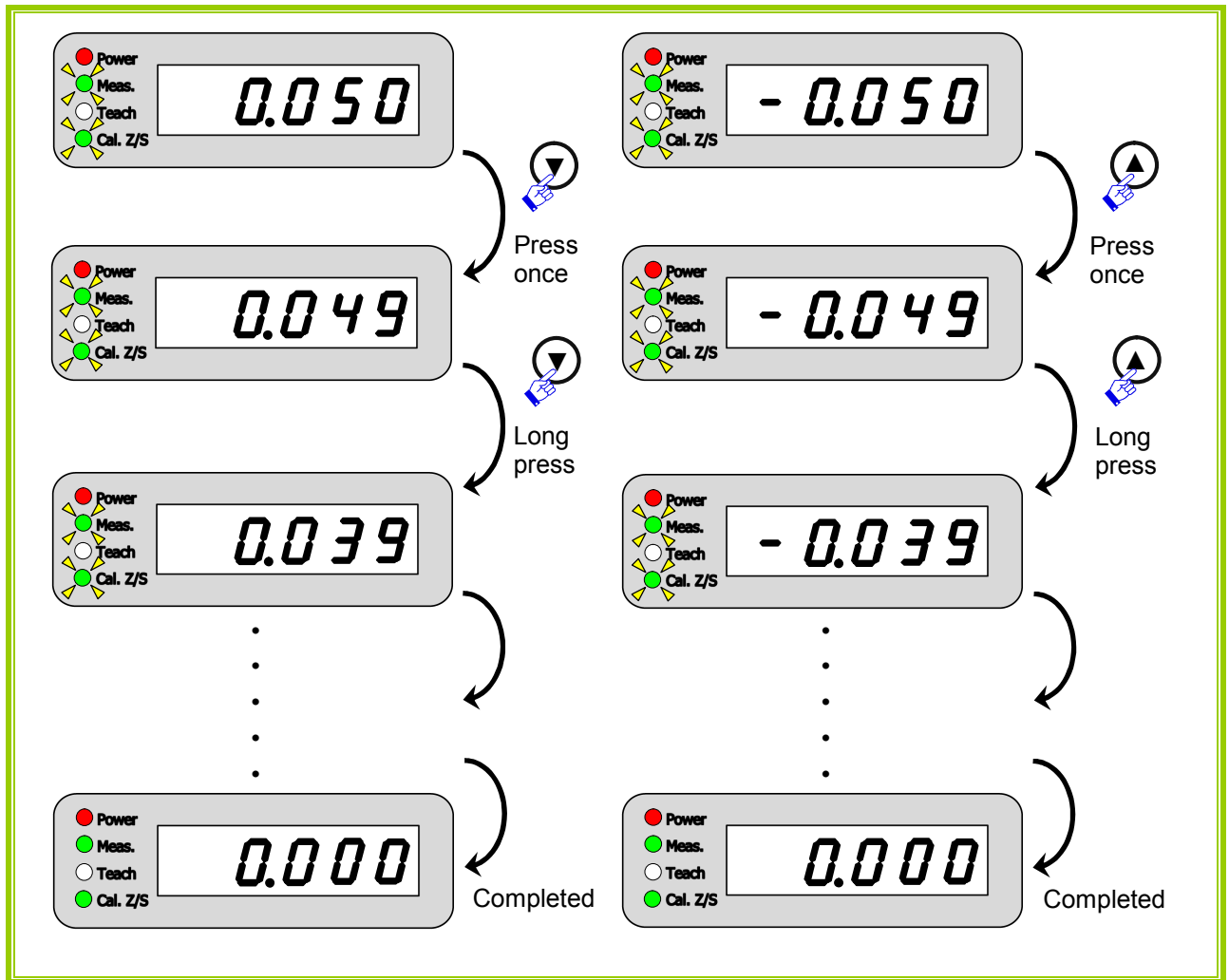

- Setting the runout center to 0 V

At 0% gap, rotate (operate) the metal roll and adjust the runout center to 0 V using the "△" and "▽" buttons.

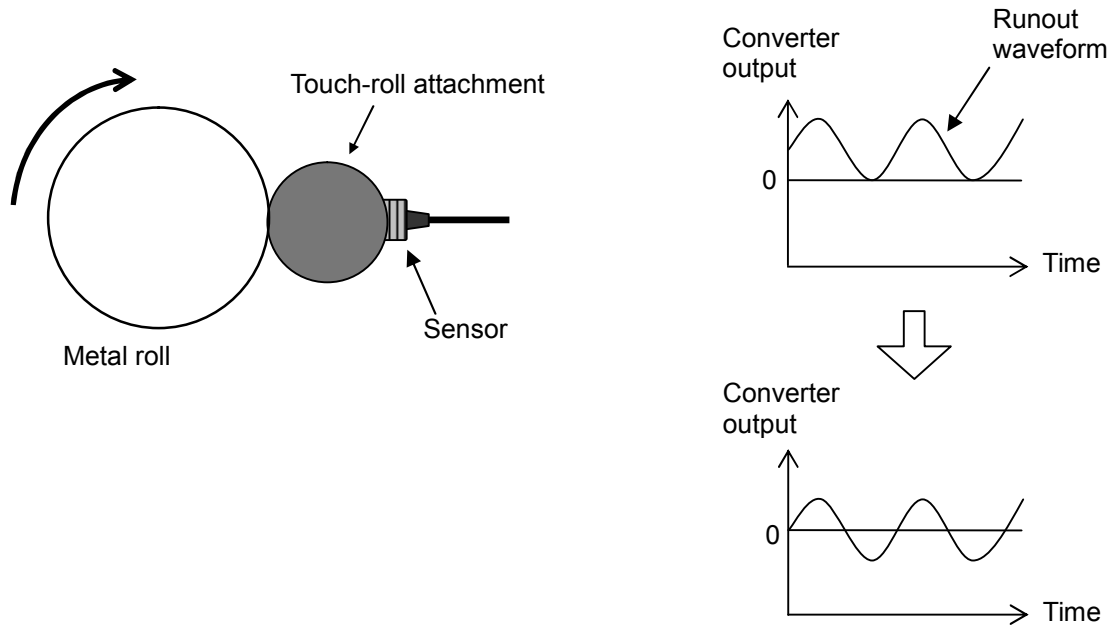

---

**CAUTION**

When performing a plating process on the metal roll (target), unevenness in the plating thickness may appear in the converter output (electrical runout).

---

## 6.6 Correction function

This function is used to correct the output in a simple manner when the zero point (0% gap), midpoint (50% gap), or span point (100% gap) is shifted.

- 2-point correction function

Correction is made in 2 points: zero point (0% gap) and span point (100% gap).

- 3-point correction function

Correction is made in 3 points: zero point (0% gap), midpoint (50% gap), and span point (100% gap).

---

**CAUTION**

If the deviation width of the zero point (0% gap), midpoint (50% gap), or span point (100% gap) is large, the linearity error margin after correction may also become large.

If this is the case, readjust the converter using the teaching function.

---

6.6.1 Using the 2-point correction function (zero point, span point)

For the button operation for switching to the calibration mode, see "Chapter 7: State Transition Diagrams through Button Operation".

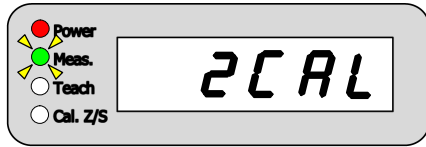

1 Select the 2-point correction function from the menu.

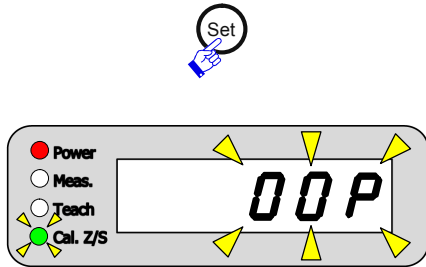

2 The "Cal. Z/S" LED will flash, and the seven-segment LED display will flash "00P".

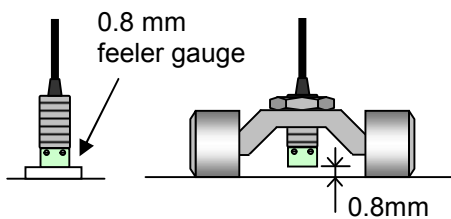

3 Set the sensor gap to 0% and press the "Set" button on the converter.

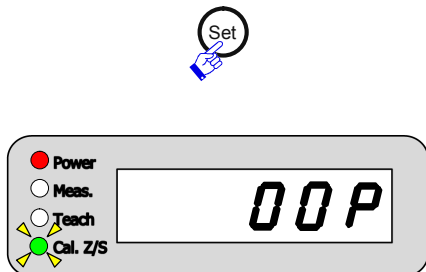

4 The seven-segment LED display will show "00P" (1.5 seconds), and then flash indicate "100P".

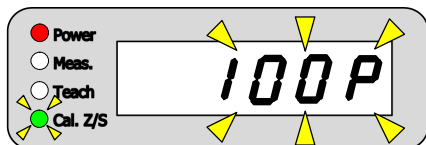

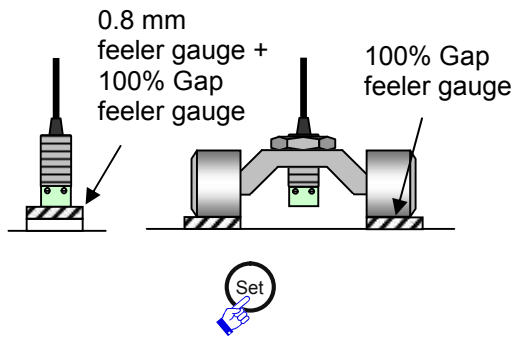

5 Set the sensor gap to 100% and press the "Set" button on the converter. \*1

\*1 When the sensor gap is 0% or smaller than 0%



/ Press the "Set" button on the converter.

// The seven-segment LED display will continuously show "- - -".

/// The seven-segment LED display will flash indicate "100P".

Insert the correct feeler gauge.

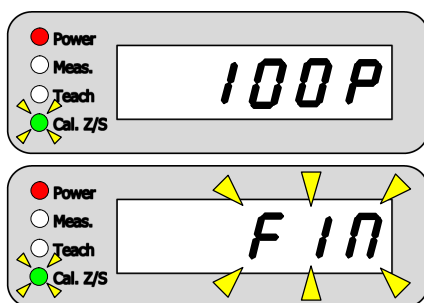

6 The seven-segment LED display will show "100P" (1.5 seconds), and then flash indicate "FIN".

(Press the converter's "Menu" button to cancel adjustment).



7 Press the converter's "Set" button to complete correction.

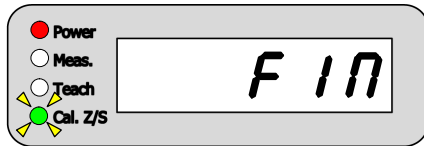

8 The seven-segment LED display will show "FIN" (1.5 seconds).

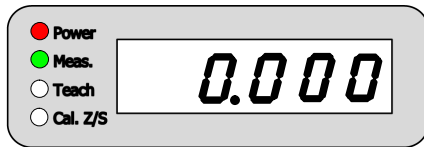

9 When correction is completed, the mode will change to the measurement mode.

The seven-segment LED display will switch to the thickness value.

At the same time, the "Cal. Z/S" LED will go off then the "Meas." LED will turn on.

Press the converter's "Menu" button to cancel the correction procedure at any point from Step 2 to 6.



6.6.2 Using the 3-point correction function (zero point, midpoint, span point)

For the button operation for switching to the calibration mode, see "Chapter 7: State Transition Diagrams through Button Operation".

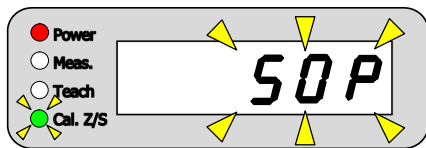
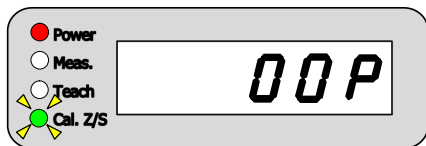
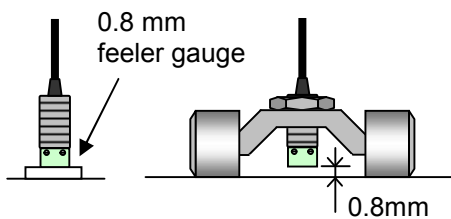
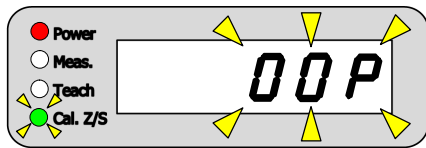
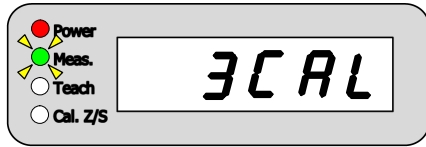

1 Select the 3-point correction function from the menu.

2 The "Cal. Z/S" LED will flash, and the seven-segment LED display will flash "00P".

3 Set the sensor gap to 0% and press the "Set" button on the converter.

4 The seven-segment LED display will show "00P" (1.5 seconds), and then flash indicate "50P".

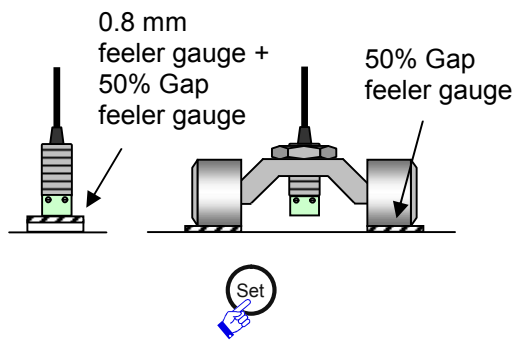

**5** Set the sensor gap to 50% and press the "Set" button on the converter. \*2

\*2 When the sensor gap is 0% or smaller than 0%



**I** Press the "Set" button on the converter.

**II**

The seven-segment LED display will continuously show "- - -".

**III**

The seven-segment LED display will flash indicate "50P".

Insert the correct feeler gauge.

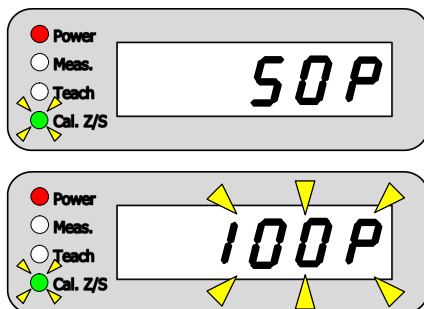

**6** The seven-segment LED display will show "50P" (1.5 seconds), and then flash indicate "100P".

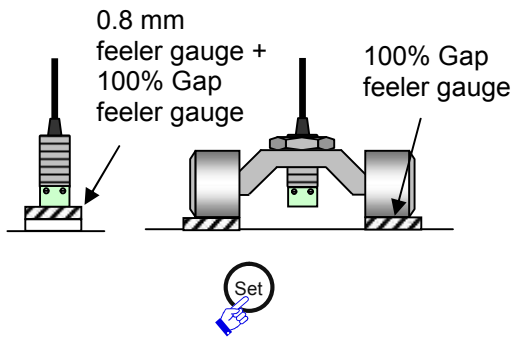

7 Set the sensor gap to 100% and press the "Set" button on the converter. \*3

\*3 When the sensor gap is 50% or smaller than 50%



/ Press the "Set" button on the converter.

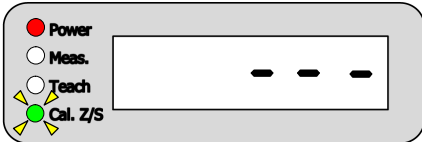

// The seven-segment LED display will continuously show " - - -".

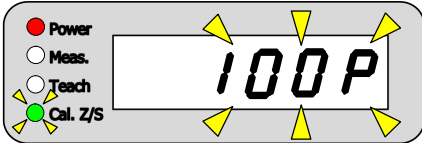

/// The seven-segment LED display will flash indicate "100P".

Insert the correct feeler gauge.

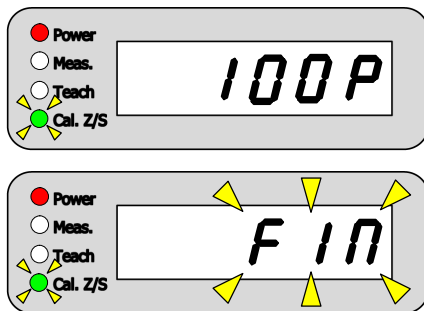

8 The seven-segment LED display will show "100P" (1.5 seconds), and then flash indicate "FIN".

(Press the converter's "Menu" button to cancel adjustment).



9 Press the converter's "Set" button to complete correction.

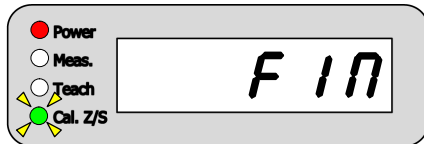

**10** The seven-segment LED display will show "FIN" (1.5 seconds).

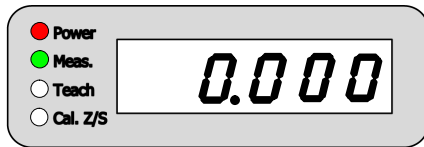

**11** When correction is completed, the mode will change to the measurement mode.

The seven-segment LED display will switch to the thickness value.

At the same time, the "Cal. Z/S" LED will go off then the "Meas." LED will turn on.

Press the converter's "Menu" button to cancel the correction procedure at any point from Step **2** to **8**.

## 6.7 Button lock function

After power-on, the product does not accept button operations (button locked state).

The button lock can be released using the following button operations:

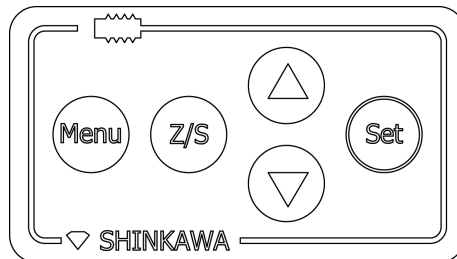

While pressing and holding the [Menu] button,  
[Z/S] button (press) -> [△] button (press) -> [▽] button (press) -> [Set] button (long press)

When the button lock is released, "unLK" is displayed on the converter's digital display for about 1 second.  
After releasing the button lock, you can display the menu and adjust the converter using button operations.

\* If there is no button operation for approximately 5 minutes after the button lock was released, the product will automatically go into the button locked state.

- Manually setting the button lock



- 1 Select the button lock function from the menu.

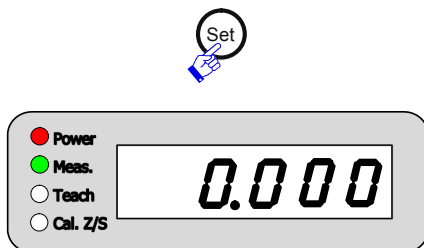

- 2 The "Meas." LED will turn on, button lock will be set, and the mode will change to the measurement mode.

## 6.8 Reset function

The reset function enables you to reset the product to factory settings.

Use this function if adjustment could not be done properly despite using the adjustment function and correction function.

- Using the reset function

The reset function can be called using the button operations below while in the calibration mode.

For the button operation for switching to the calibration mode, see "Chapter 7: State Transition Diagrams through Button Operation".

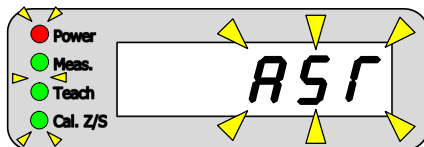
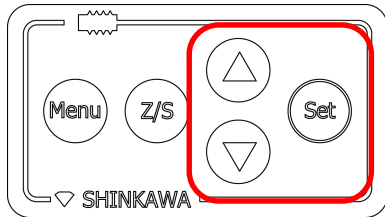

- 1 While in the calibration mode, press and hold "Set +  $\Delta$  +  $\nabla$ ".

- 2 All LEDs that display status will flash, and the seven-segment LED display will flash indicate "RST".

Press the converter's "Set" button to reset the product.

Press the converter's "Menu" button to cancel the reset.

# Chapter 7 State Transition Diagrams through Button Operation

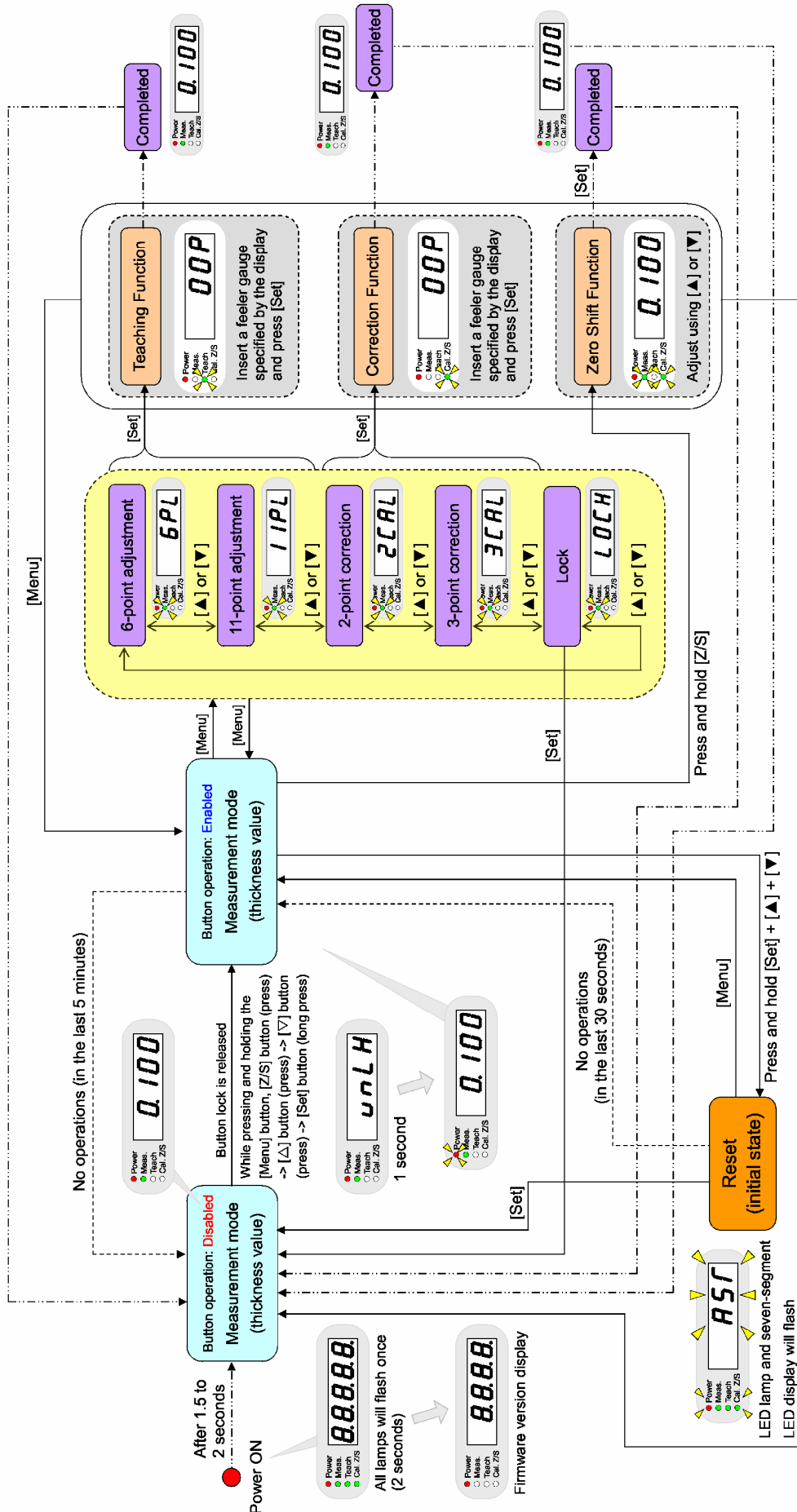

\* When using the zero shift function, if there is no button operation for one minute from the last button operation, the current adjustment value will automatically be applied and the mode will change to the button operation disabled mode (measurement mode).

## Chapter 8 Troubleshooting

Symptoms	Possible cause	Countermeasure
The LED of the digital display part and the seven-segment LED display does not turn on.	The power is not on.	Turn on the power.
	A safety device activated due to overvoltage	Check the power supply voltage and the wiring. You may need to replace the product.
The output voltage does not change.	Connections were done incorrectly.	See "3.4 Connections" on how to perform connections properly.
	The sensor's offset gap greatly deviates from 0.8 mm.	Perform offset gap setting using a feeler gauge.
	Measurement deviates from the measurement range.	Review the measurement range.
	The converter is broken.	The product needs to be replaced.
The output voltage and digital display show a value of 0% gap or lower and does not change.	The sensor or extension cable is broken.	The product needs to be replaced.
When the teaching function is used, the digital display shows "---" and cannot be adjusted.	The sensor's offset gap deviates from 0.8 mm.	Perform offset gap setting using a feeler gauge.
	A different feeler gauge thickness is used.	Use a feeler gauge with the correct gap.
	Adjustment is being performed outside the measurement range.	Review the measurement range and check the sensor's offset gap.
	The target material actually being used is different from the target material calibrated by SHINKAWA Sensor Technology, Inc.	Check the target material being used.
The output voltage becomes lower than the specified value even when using the teaching function.	The converter output is connected to a device with lower impedance.	The output impedance for this product is 100 Ω. Change the device connected to the converter output with a high input impedance device. Alternatively, you can isolate the device which connects to the converter output.
"tErr" is displayed on the digital display and the output voltage does not change.	The product is being used in an environment with a temperature different from the operating temperature.	Check the ambient temperature.
	The converter is broken.	The product needs to be replaced.
Proper adjustment is not performed even when using the teaching function.	There is a metallic object near the sensor tip other than the target.	Check if there is a metallic object near the sensor tip other than the target.
Button operations cannot be performed.	The buttons are locked.	See "Chapter 7: State Transition Diagrams through Button Operation" on how to release the button lock.



## Chapter 9 Maintenance/Inspection

### 9.1 Periodic inspection

In order to maintain performance and system stability of this product, it is recommended that you adjust the converter regularly by referring to "6.2 Teaching function".

Also check the sensor, extension cable, and converter's exterior for any abnormalities.

### 9.2 Cleaning

Remove dust which accumulates on the terminal block.

Use a dry cloth when wiping off stains.

\* Do not use chemicals or solvents.

---

**CAUTION**

When cleaning this product, disconnect the power to the converter.

---

### 9.3 Recommended replacement cycle

It is recommended that this product be replaced every 5 years even if it is still working properly.

**Point**

Deterioration of this product also depends on the surrounding environment.

The product's operating life becomes shorter when used in environments with high temperature or corrosive gases.

The recommended replacement period of this product is 5 years to ensure the stability of the system.

**Chapter 10 Individual Characteristics Data (Examples)**

10.1 Standard static characteristics

[Measurement conditions]  
 2 mm range  
 Target material: flat chilled steel

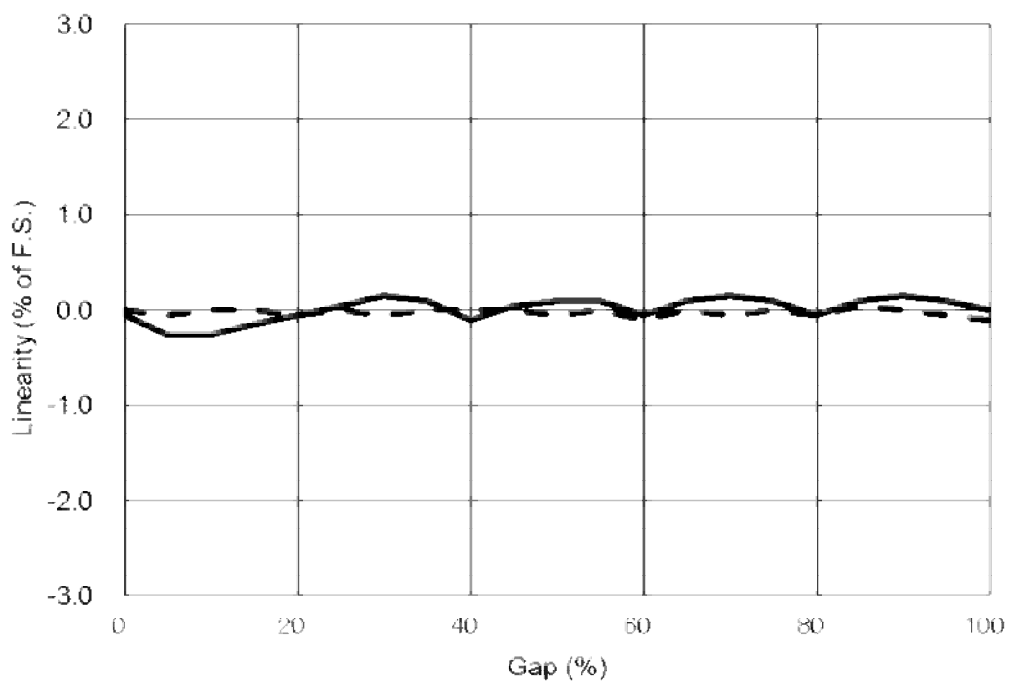
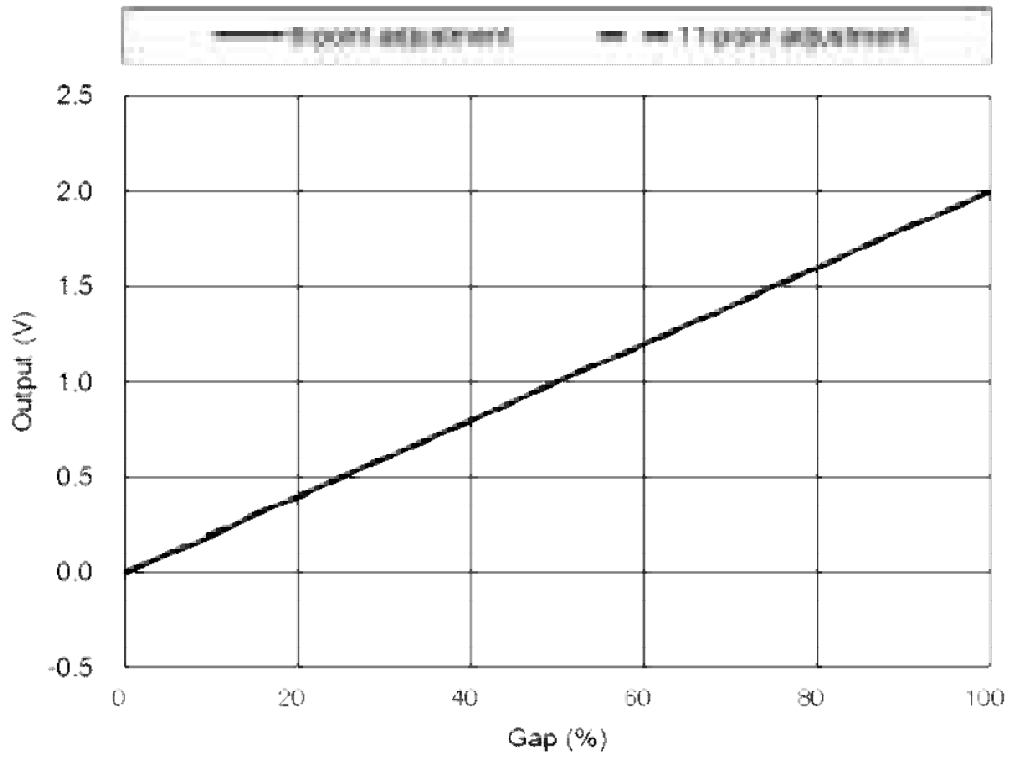

10.2 Temperature characteristics of the sensor

[Measurement conditions]

2 mm range

Set gap: 50% of the thickness measurement range

Target material: flat chilled steel

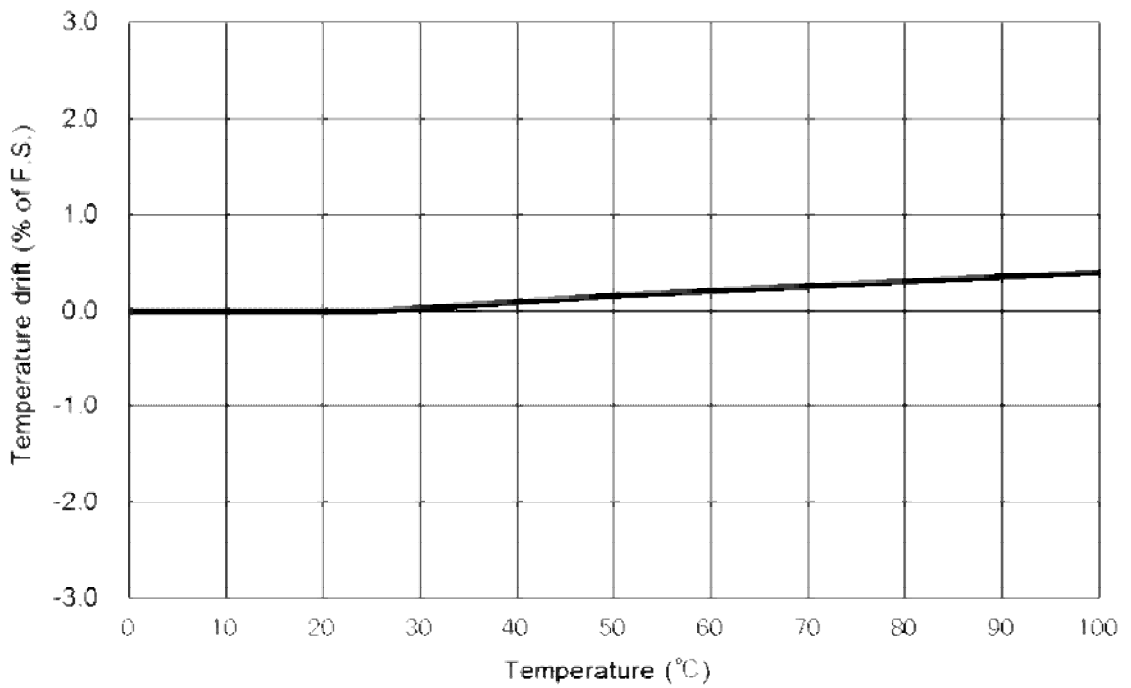

10.3 Temperature characteristics of the extension cable

[Measurement conditions]

2 mm range

Set gap: 50% of the thickness measurement range

Target material: flat chilled steel

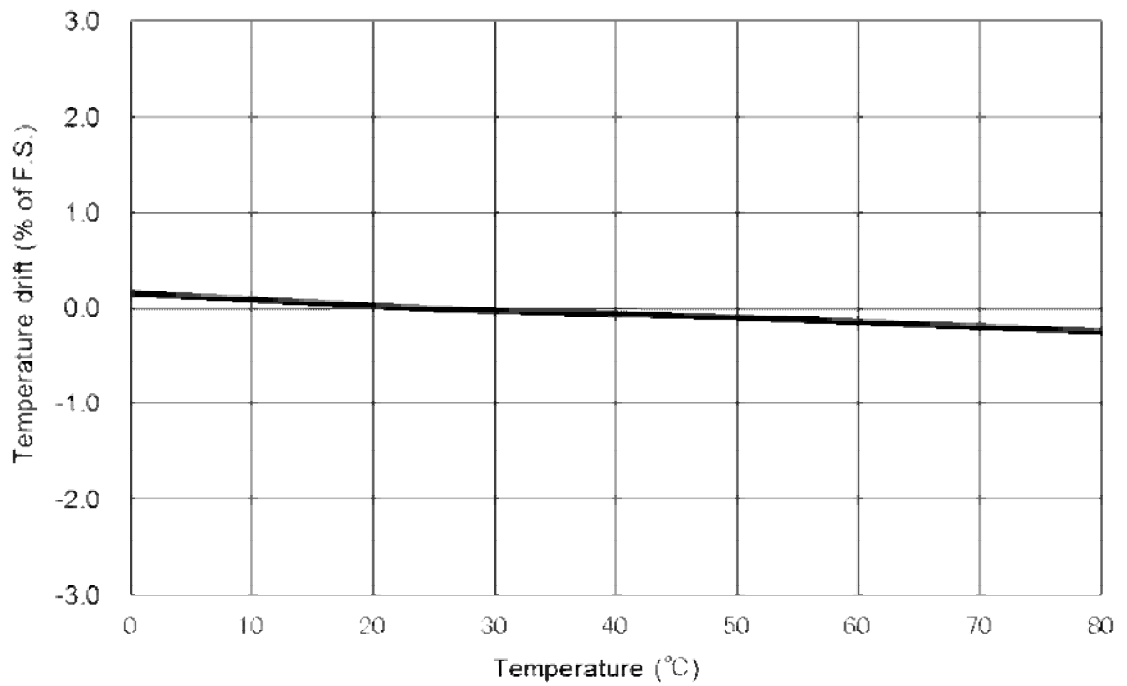

10.4 Temperature characteristics of the converter

[Measurement conditions]

2 mm range

Set gap: 50% of the thickness measurement range

Target material: flat chilled steel

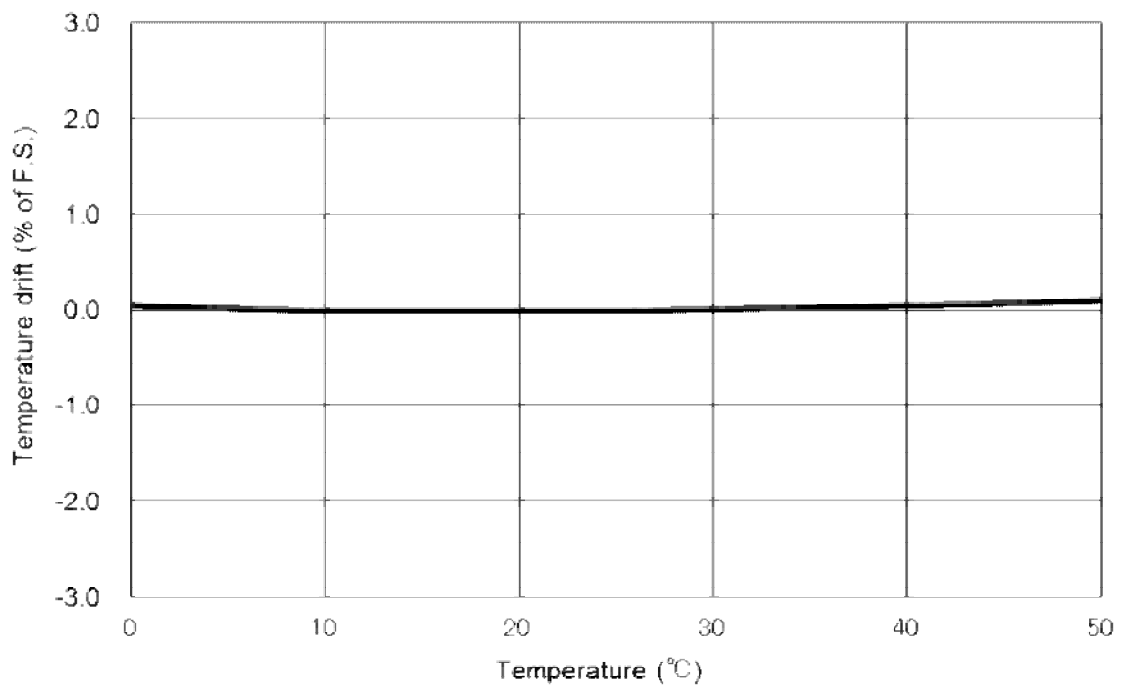



---

# Hardware Warranty

---

## 1. Warranty conditions

- The warranty period for the delivered product is 3 years (1 year for special products) from the time of shipment from our factory. If a failure occurs in the delivered product due to our fault during this warranty period, we will take responsibility for the replacement/repair of that product.
- Also, if it becomes necessary to dispatch an engineer within the warranty period, traveling expenses based on our company regulations will be charged. The repair cost at this time will be covered by our company.
- The warranty here covers the delivered product only, and we will not take responsibility for any direct or indirect damages caused by the malfunction of the delivered product.
- Warranty periods and coverage of warranties for devices manufactured by those other than our company will be at the responsibilities and conditions of those respective manufacturers, regardless of this document.
- If one of the following conditions applies, the failure will not be covered by this warranty.

- (1) Improper handling or use by the customer.
- (2) If the cause of the problem is due to a reason other than by the fault of our company.
- (3) If there were modifications or repairs made by a party other than our company or persons specified by our company.
- (4) Handling, storage, or usage under severe environments exceeding hardware design specification conditions.
- (5) Problems caused by fires, floods, earthquakes, lightning strikes and other natural disasters.
- (6) A lifetime parts. (Electrolytic capacitor , etc.)
- (7) Other failures that are not at the fault of our company.

## 2. Warranty conditions for repaired products

The Warranty period for repaired items will be 6 months after the date of repairs for that item. Other conditions will be as 1. above.



## **SHINKAWA Sensor Technology, Inc.**

### **Hiroshima Factory**

4-22, Yoshikawakogyodanchi, Higashihiroshima-shi, Hiroshima 739-0153, JAPAN

Tel. +81-82-429-1118 Fax. +81-82-429-0804

[Quality Assurance Group] E-Mail : [service@sst.shinkawa.co.jp](mailto:service@sst.shinkawa.co.jp)